



**Price Computing Scale**  
**D Series**  
**Operation Manual**

8529-M400-O1 Rev. B 11/15  
CARDINAL SCALE MFG. CO.  
203 E. Daugherty, Webb City, MO 64870 USA  
Ph: 417-673-4631 • Fax: 417-673-5001  
[www.detectoscale.com](http://www.detectoscale.com)

Technical Support: Ph: 866-254-8261 • [tech@cardet.com](mailto:tech@cardet.com)

## INTRODUCTION

Thank you for purchasing our Detecto D Series Price Computing Scale. Your scale has been designed to operate from 115 VAC 50/60 Hz or with the included rechargeable battery pack.

This manual will guide you through setup and operation of your scale. Please read it thoroughly before attempting to operate this scale and keep it handy for future reference.

## FCC COMPLIANCE STATEMENT

This equipment generates uses and can radiate radio frequency and if not installed and used in accordance with the instruction manual, may cause interference to radio communications. It has been tested and found to comply with the limits for a Class A computing device pursuant to Subpart J of Part 15 of FCC rules, which are designed to provide reasonable protection against such interference when operated in a commercial environment. Operation of this equipment in a residential area may cause interference in which case the user will be responsible to take whatever measures necessary to correct the interference.

You may find the booklet "How to Identify and Resolve Radio TV Interference Problems" prepared by the Federal Communications Commission helpful. It is available from the U.S. Government Printing Office, Washington, D.C. 20402. Request stock No. 001-000-00315-4.



## COPYRIGHT

All rights reserved. Reproduction or use, without expressed written permission, of editorial or pictorial content, in any manner, is prohibited. No patent liability is assumed with respect to the use of the information contained herein.

## DISCLAIMER

While every precaution has been taken in the preparation of this manual, the Seller assumes no responsibility for errors or omissions. Neither is any liability assumed for damages resulting from use of the information contained herein. All instructions and diagrams have been checked for accuracy and ease of application; however, success and safety in working with tools depend to a great extent upon the individual accuracy, skill and caution. For this reason the Seller is not able to guarantee the result of any procedure contained herein. Nor can they assume responsibility for any damage to property or injury to persons occasioned from the procedures. Persons engaging the procedures do so entirely at their own risk.

<b>Serial Number</b> _____
<b>Date of Purchase</b> _____
<b>Purchased From</b> _____
_____
_____
RETAIN THIS INFORMATION FOR FUTURE USE

<h3>PRECAUTIONS</h3> <p>Before using this instrument, read this manual and pay special attention to all "WARNING" symbols:</p> <div style="display: flex; justify-content: space-around; align-items: center;"><div style="text-align: center;"><p>IMPORTANT</p></div><div style="text-align: center;"><p>ELECTRICAL WARNING</p></div></div>
--

# TABLE OF CONTENTS

SPECIFICATIONS .....	1
INSTALLATION .....	2
Unpacking .....	2
Placement .....	2
Level Adjustment .....	2
Power Connection .....	2
Printer Connection .....	2
ANNUNCIATORS .....	3
KEY FUNCTIONS .....	4
OPERATION .....	5
Power Switch .....	5
Weight Display .....	5
Standard Unit Price Computation .....	5
Pre-Pack Operation .....	5
Tare Operation .....	6
Sample Labels .....	6
PRICE LOOK UP (PLU) OPERATION .....	7
SCALE SETTINGS .....	8
ERROR AND STATUS DISPLAYS .....	9
BEFORE YOU CALL SERVICE .....	9
CARE AND CLEANING .....	9

## SPECIFICATIONS

Display:	0.5" High Seven-Segment LCD with backlight Weight = 6 Digits Unit Weight = 6 Digits Total Price = 6 Digits
Dimensions:	13.39" W x 13.39" D x 5.00" H (340 mm x 340 mm x 127 mm)
Platform Size	12.60" W x 9.06" D (320 mm x 230 mm)
Model D15 D30 D60	Capacity and Division Value 15 lb x .005 lb (6 kg x .002 kg) 30 lb x .01 lb (15 kg .005 kg) 60 lb x .02 lb (30 kg .01 kg)
Zero	Established on power up routine and maintained by auto-zero circuitry
Power	12 VDC 1.0 A Rechargeable battery pack or AC Adapter 110/120 VAC 50/60Hz
Tare	100% of full scale capacity
Operating Temperature	32 ~ 104°F (0° ~ 40°C)
Interface:	RS-232 Serial Port, 9-Pin (DB-9), Baud Rate 9600

# INSTALLATION

## Unpacking

Before beginning installation of your D Series Price Computing Scale, make certain the instrument has been received in good condition. Carefully remove the instrument from the shipping carton and inspect it for any evidence of damage (such as exterior dents or scratches) that may have taken place during shipment. Keep the carton and packing material for return shipment if it should become necessary. It is the responsibility of the purchaser to file all claims for any damages or loss incurred during transit.

## Placement

Place the scale in an environment free of excessive dust and moisture and on a stable, vibration-free level surface away from direct sunlight and any rapidly moving air source (heating/cooling vents, fans, etc.). This will prevent sudden temperature changes and air currents that may result in unstable weight readings. Keep the area around the scale clear to provide adequate air circulation and make certain the power cord is routed out of the way of normal traffic.



**CAUTION! DO NOT place the scale on any unstable cart, stand or table. The scale may fall causing injury to the operator, and damage the unit, or proper operation of the scale may be inhibited.**

## Level Adjustment

Check to make certain the scale is level. The level indicator is located at the front of the scale. If the scale is not level (the bubble will not be centered), loosen the locking ring on all four (4) mounting feet and adjust them as required to center the bubble and attain a level scale. Once the scale is level, lock the mounting feet in place by tightening the adjustment locking rings against the bottom of the scale.

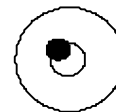

**Not Levelled**

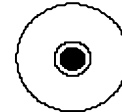

**Levelled**

## Power Connection

The scale uses an external AC power adapter that converts the 110/120 VAC 50/60Hz wall supply to the 12VDC power required by the scale. The scale also has circuitry necessary to monitor and recharge the battery and is capable of operating the scale and recharging the battery simultaneously.



**NOTE: In areas subject to lightning strikes, additional protection (surge suppressors) should be installed.**

## Printer Connection

1. Attach RS232 cable to port at rear of printer.
2. Attach power cable from printer AC adapter to jack at rear of printer.
3. Attach RS232 cable to port on underside of scale.
4. Attached power cable of scale to jack on underside of scale.
5. Plug both AC adapter power supplies into power outlet.
6. Turn scale on – power switch on underside of right side of scale.
7. Turn printer on – power switch at rear of printer.

# ANNUNCIATORS

Annunciators indicate the active mode or functions of the scale. The meaning of each annunciator is described below.

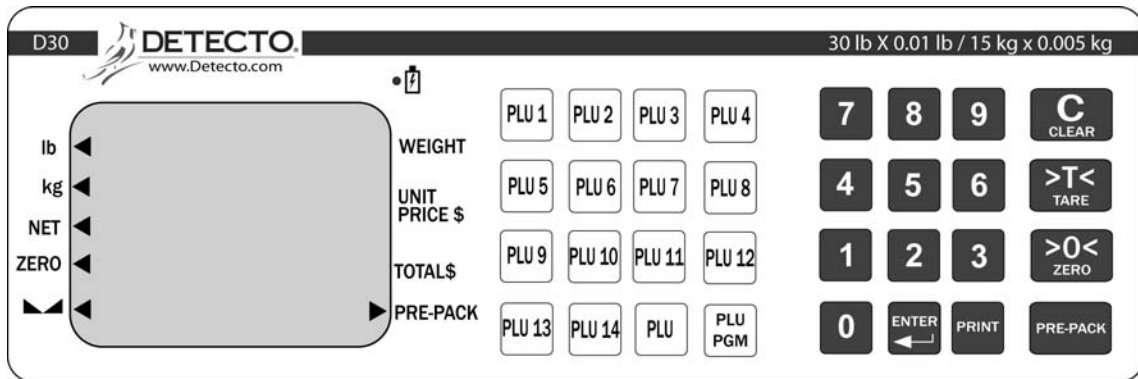

Front - Operator Keypad and Display



Rear - Customer Display

## ZERO

The ZERO annunciator is located to the left of the display and is selected to indicate that the gross scale weight is zero.

## NET

The NET annunciator is located to the left of the display and indicates the displayed weight is the net weight. Net weight is determined by subtracting the tare weight from the gross or scale weight. The tare weight, usually the weight of the container, is entered using the tare key. Note that the NET annunciator is only active when a zero tare weight or tare weight value is stored and the display is in the weight mode.

## kg

The kg annunciator indicates weight displayed is in kilograms and the UNIT PRICE is per kilogram.

## lb

The lb annunciator indicates weight displayed is in pounds and the UNIT PRICE is per pound.

## PRE-PACK

Indicates the scale is in the PRE-PACK mode. The PRE-PACK mode is used for repetitive price computing.



Indicates weight on scale is stable



Red Light indicates the battery is charging.  
Green light indicates the battery is fully charged.

## KEY FUNCTIONS

This section describes the use of each of the keys on the D Series Price Computing Scale. It will be helpful to refer to the scale keyboard or the figure on the previous page when reading this section.



Clears unit price  
Exits PLU and clears Tare



Set the weight display to zero and turn on the ZERO annunciator.  
*Also used in User Setup mode to return to previous step.*



Stores the current gross weight as the new tare weight and changes scale to the net weight mode.



Retains the Unit Price and Tare for repetitive price computing.



Enter input



Print Label



Price Look Up for PLU 15-99



Program Price Look Up PLU 1-99



Price Look Up for PLU 1-14



Numeric keys 0-9



The membrane keypad is not to be operated with pointed objects (pencils, pens, fingernails, etc). Damage to keypad resulting from this practice will *NOT* be covered under warranty.

# OPERATION

## Power Switch

The Power Switch is located on the bottom right side panel towards the front of the scale. Place the power switch in the on position. The scale will perform a brief display test illuminating all display segments and annunciator LED's to allow the operator to make a visual verification that the display is operational. After completion of the display test, the software version will be displayed, the weight display will show zero weight indicating the scale is ready for use.



Before using the scale, it should be “warmed up” (turned on and unloaded for approximately 15 to 20 minutes).

## Weight Display

### Displaying Weight

1. With the scale in the weigh mode [ 0.000 ] will be displayed on the Weight display and [ 0.00 ] will be displayed on the UNIT PRICE and TOTAL PRICE displays, place the item to be weighed on the scale platform.
2. The WEIGHT display will show the weight on the scale platform. NOTE: The UNIT PRICE and TOTAL PRICE displays will remain at [ 0.00 ].

### Zero the Weight Display

1. Press the **ZERO** key.
2. The weight display will return to zero. The ZERO annunciator will illuminate, indicating a center-of-zero gross weight condition.

## Standard Unit Price Computation

1. Place commodity on scale.
2. Enter UNIT PRICE.
3. Read WEIGHT and TOTAL PRICE.
4. If a label printer is connected to the scale, press **PRINT** key to print a label.
5. Remove commodity. Weight will return to zero and prices will be cleared.

## Pre-Pack Operation

For repetitive price-computing of commodities with the same unit price.

1. Enter tare if so desired as outlined in **Tare Operation**. Tare entry will be retained in PRE-PACK mode.
2. Enter unit price and press the **PRE-PACK** key. The PRE-PACK annunciator will illuminate.
3. Place commodities on scale.
4. If a label printer is connected to the scale, press **PRINT** key to print a label.
5. When the pre-packing operation is ended, press the **CLEAR** key to clear unit price, turn off PRE-PACK mode and clear Tare.

# OPERATION, CONT.

## Tare Operation

1. Place empty container on scale.
2. Press the **TARE** key.
3. The **WEIGHT** display will change to zero and the **NET** weight annunciator will illuminate.
4. Key in unit price.
5. Place commodity in container. Net weight of commodity will be displayed.
6. Read net commodity weight and total price.
7. If a label printer is connected to the scale, press **PRINT** key to print a label.
8. Remove container and commodity from scale.
9. Scale will return to zero and clear tare and unit price information.
10. Scale is ready for next operation.

## Sample Labels

Standard Unit Price:

Weight  
 PLU#  
 Unit Price  
 Total Price

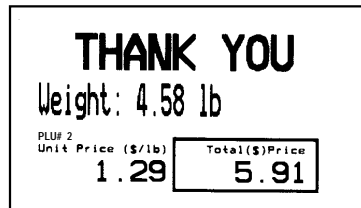

Unit Price with maximum digits:

Weight  
 Unit Price  
 Total Price

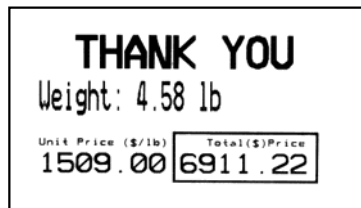

Total Price exceeds digit print capacity:

Weight  
 Unit Price  
 -----

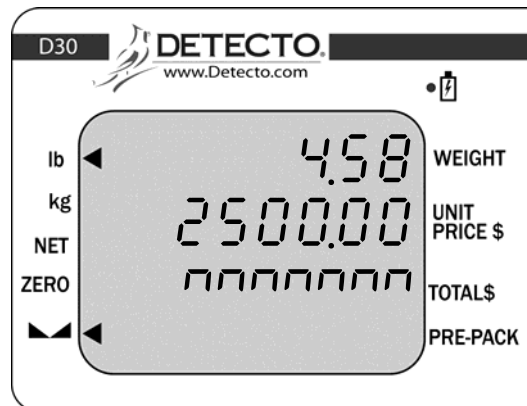
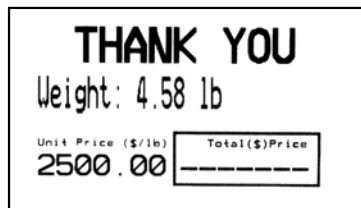

Scale display with Total Price digit capacity exceeded.



# PRICE LOOK UP (PLU) OPERATION

## PLU Programming

### Programming PLU without a Tare Weight

1. Press the **PLU PGM** key
2. Press the PLU key (PLU1 – PLU14) or enter the PLU number (15-99) to programmed.
3. Press **ENTER**
4. Enter the UNIT PRICE and press **ENTER** twice.

### Programming PLU with a Tare Weight

1. Press the **PLU PGM** key
2. Press the PLU key (PLU1 – PLU14) or enter the PLU number (15-99) to programmed.
3. Press **ENTER**
4. Enter the UNIT PRICE and press **ENTER**
5. Enter the known Tare weight or place the empty container on the scale and press **ENTER**.

## PLU Operation

1. Press the key for the desired PLU (PLU1-PLU14 key or PLU key then number 15-99)
2. The PLU Unit Price will be displayed.
3. If a Tare weight is programmed for the selected PLU, the Weight displayed will be negative and the NET annunciator illuminated.
4. Place the commodity on the scale. Be sure to use the proper container if a Tare weight is programmed.
5. The Total Price will be displayed.
6. If a label printer is connected to the scale, press the **PRINT** key to print a label.
7. Remove the commodity, the scale will exit the PLU and return to zero weight.

## Pre-Pack Operation with PLU

For repetitive price-computing of commodities with the same unit price.

1. Select the desired PLU as above.
2. Press the **PRE-PACK** key. The PRE-PACK annunciator will illuminate.
3. Place commodities on scale.
4. If a label printer is connected to the scale, press the **PRINT** key to print a label.
5. Repeat until all commodities have been weighed.
6. When the pre-packing operation is ended, press the **CLEAR** key to turn off PRE-PACK mode and exit PLU.

# SCALE SETTINGS

Access User setup with scale off, press and hold the **PRE-PACK** key while switching the scale on. Scale will display *SEtUP*. Use the following keys to navigate settings shown below.

PRE-PACK ↓ Accept the displayed setting and to proceed to next step

TARE → Toggles available settings for the current step

ZERO ↑ Returns to previous step

CLEAR Exits setup and proceeds to SAVE

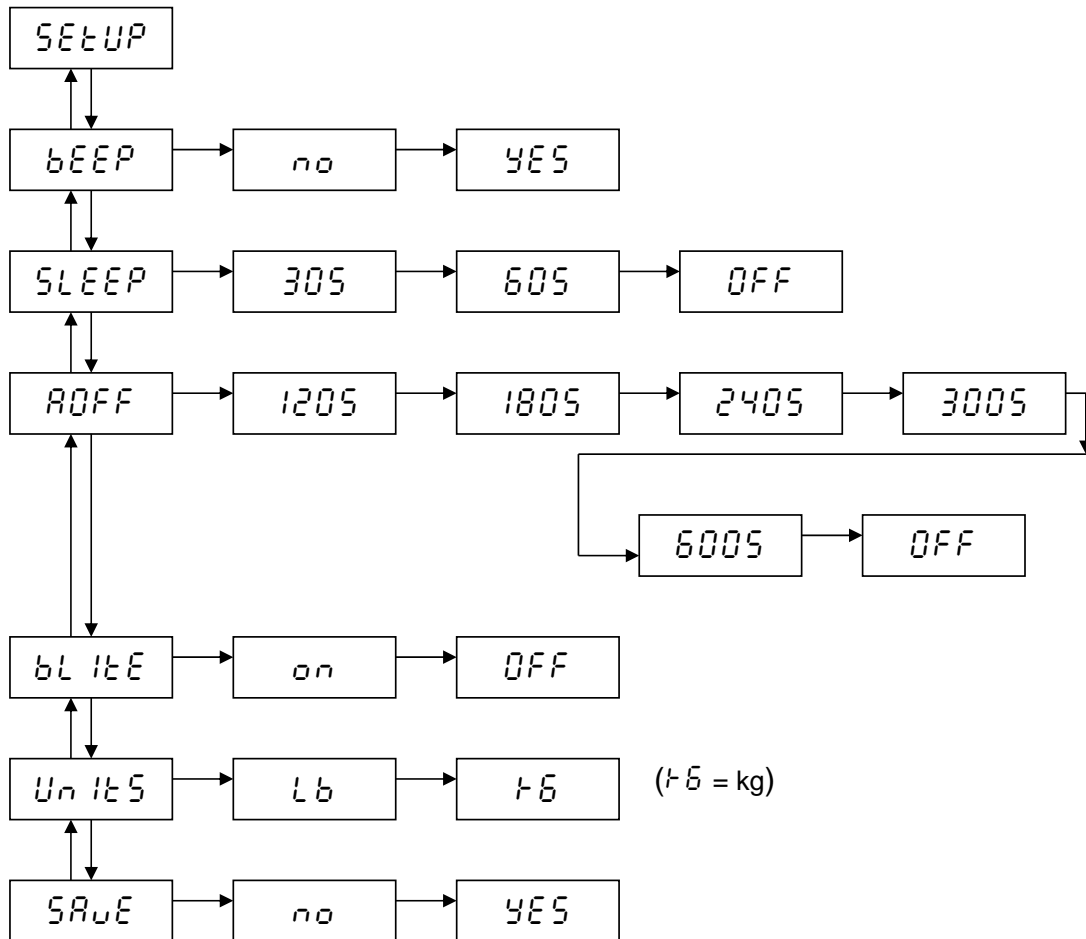

**NOTE:** No set-up is required for Printer Port. It is pre-configured as OUTPUT only.

## ERROR AND STATUS DISPLAYS

The D Series Price Computing Scale is equipped with a diagnostic software program that tests various portions of the instrument's circuitry and verifies proper operation. Should a problem be detected, an error or status message will be displayed alerting the operator to that condition. The following lists these error messages and their meanings.

Display	Meaning
<i>OCAP</i>	Over Capacity - Indicates the scale weight capacity has been exceeded.
<i>Lo bAt</i>	Low Battery - Indicates the internal battery requires charging.
<i>ErrE</i>	E EPROM error
<i>ErrH</i>	Zero value too high
<i>ErrL</i>	Zero value too low
<i>ErrS</i>	Keypad error

## BEFORE YOU CALL FOR SERVICE

Your D Series Price Computing Scale has been designed to provide you with years of trouble-free operation. In spite of this, troubles sometimes happen. Before calling for service assistance you should make some initial checks to verify that a problem does exist. The following describes several types of symptoms along with suggested remedies.

PROBLEM	POSSIBLE SOLUTIONS
Display does not turn on	AC Operation: <ul style="list-style-type: none"><li>• Is the AC power cord fully inserted into the wall receptacle?</li><li>• Check wall receptacle for proper AC power. Try another electrical appliance in the same receptacle. Does it work?</li><li>• Check the circuit breaker.</li><li>• Has there been power failure</li></ul> Battery operation: <ul style="list-style-type: none"><li>• Check if battery is properly installed.</li><li>• Is battery discharged? Recharge or replace battery.</li></ul>
Incorrect weight displayed	<ul style="list-style-type: none"><li>• Insure that the scale platform isn't touching an adjacent object.</li><li>• Have proper operation procedures been followed?</li></ul>

## CARE AND CLEANING

- **DO NOT** submerge the scale in water, pour or spray water directly on it.
- **DO NOT** use acetone, thinner or other volatile solvents for cleaning.
- **DO** clean the indicator with a damp soft cloth and mild non-abrasive detergent.
- **DO** remove power before cleaning with a damp cloth.
- **DO** clean and store the scale in a plastic bag (in a dry environment) if the scale is not going to be used for some time. A desiccant packet may be included to prevent moisture build up.
- **DO** recharge the internal battery every three months while in storage.

