



Digital Clinical Scale
with Wi-Fi and Bluetooth 5.0
Owner's Manual

INTRODUCTION

Thank you for purchasing our Detecto icon® Digital Clinical Scale. It has been manufactured with quality and reliability and has been tested before leaving our factory to ensure accuracy and dependability for years to come.

This manual is provided to guide you through installation and operation of your scale. Please read it thoroughly before attempting to install or operate your scale and keep it available for future reference.

This manual is for use with the following icon® models:

ICON	ICON-UK	ICON-EU
ICON-LXI	ICON-UWA	ICON-EU-VER

Copyright

All rights reserved. Reproduction or use, without expressed written permission, of editorial or pictorial content, in any manner, is prohibited. No patent liability is assumed with respect to the use of the information contained herein.

Disclaimer

While every precaution has been taken in the preparation of this manual, the Seller assumes no responsibility for errors or omissions. Neither is any liability assumed for damages resulting from use of the information contained herein. All instructions and diagrams have been checked for accuracy and ease of application; however, success and safety in working with tools depend to a great extent upon the individual accuracy, skill and caution. For this reason, the Seller is not able to guarantee the result of any procedure contained herein. Nor can they assume responsibility for any damage to property or injury to persons occasioned from the procedures. Persons engaging the procedures do so entirely at their own risk.

Contains FCC ID: 2ADHKWINC3400



1. This device complies with Part 15 of the FCC rules. Operation is subject to the following two conditions:
 - (1) This device may not cause harmful interference.
 - (2) This device must accept any interference received, including interference that may cause undesired operation.
2. Changes or modifications not expressly approved by the party responsible for compliance could void the user's authority to operate the equipment.

FCC Radiation Exposure Statement

This equipment complies with FCC RF radiation exposure limits set forth for an uncontrolled environment. This transmitter must not be co-located or operated in conjunction with any other antenna or transmitter. This equipment must be installed and operated with a minimum distance of 20 cm between the radiator and user body.

Serial Number _____
Date of Purchase _____
Purchased From _____

RETAIN THIS INFORMATION FOR FUTURE USE

PRECAUTIONS	
Before using this scale, read this manual and pay special attention to all "NOTIFICATION" symbols:	
	
IMPORTANT	ELECTRICAL WARNING

PROPER DISPOSAL

When this device reaches the end of its useful life, it must be properly disposed of. It must not be disposed of as unsorted municipal waste. Within the European Union, this device should be returned to the distributor from where it was purchased for proper disposal. This is in accordance with EU Directive 2002/96/EC. Within North America, the device should be disposed of in accordance with the local laws regarding the disposal of waste electrical and electronic equipment.

It is everyone's responsibility to help maintain the environment and to reduce the effects of hazardous substances contained in electrical and electronic equipment on human health. Please do your part by making certain that this device is properly disposed of. The symbol shown to the right indicates that this device must not be disposed of in unsorted municipal waste programs.



CAUTION



CAUTION: RISK OF EXPLOSION IF BATTERY IS REPLACED BY AN INCORRECT TYPE. DISPOSE OF USED BATTERIES ACCORDING TO THE INSTRUCTIONS.

ATTENTION: RISQUE D'EXPLOSION SI LA BATTERIES EST REMPLAC'E PAR UN TYPE INCORRECT. REJETEZ LES BATTERIES UTILISE'ES SELON LES INSTRUCTIONS.

TRANSPORTATION AND STORAGE



Do Not Drop

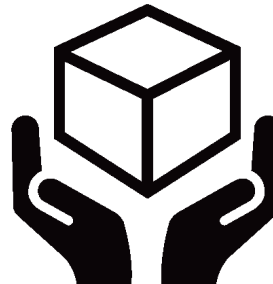

Handle with Care



Keep Dry

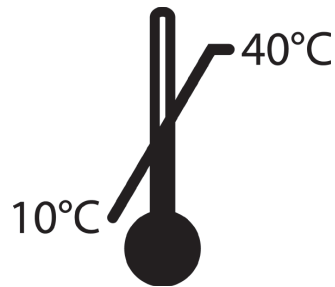

Temperature Range

TABLE OF CONTENTS

SPECIFICATIONS	Page 1
Standard Features	Page 1
Optional Features	Page 1
SITE PREPARATION REQUIREMENTS	Page 2
UNPACKING	Page 3
ASSEMBLY	Page 3
INTERCONNECTIONS	Page 6
AC Power Adapter	Page 6
USB	Page 6
Height Rod – Detecto Sonar Height Rod	Page 6
Batteries	Page 6
Battery Status	Page 6
Battery Installation/Replacement	Page 7
PLACING THE SCALE	Page 8
WEIGHING UNITS/HEIGHT MEASUREMENT SELECTION	Page 9
KEYPAD FUNCTIONS	Page 10
ANNUNCIATORS	Page 12
OPERATION	Page 13
Zero Weight Display	Page 13
Basic Weighing Operation	Page 13
Basic Weighing Operation with ID – (No BMI)	Page 13
Body Mass Index (BMI) Operation – (No ID)	Page 14
Body Mass Index (BMI) Operation with ID	Page 14
Body Mass Index (BMI) Operation (Using Previously Measured Height)	Page 15
Body Mass Index (BMI) Operation with ID (Using Previously Measured Height) ..	Page 16
MOTHER/BABY WEIGHING	Page 17
SCALE SETUP	Page 18
SONAR CALIBRATION	Page 28
SCALE CALIBRATION	Page 31
LOAD CELL TRIM	Page 44
WI-FI AND BLUETOOTH 5.0	Page 47
Wi-Fi Features	Page 47
WI-FI SETUP	Page 47
Enable and Configure Wi-Fi Networking	Page 47
Configure Wi-Fi Network Module	Page 50
Changing the Network Credentials	Page 52
Display Wi-Fi Network Settings	Page 52
WI-FI OPERATION	Page 53
Web Server	Page 53
TCP/IP Connection	Page 54
SMA Commands	Page 54

TABLE OF CONTENTS, CONT.

BLUETOOTH LOW ENERGY (BLE)	Page 55
Features Available via BLE	Page 55
Enable Bluetooth (BLE) Networking	Page 55
Bluetooth Pairing	Page 57
INTERFACING TO BLE	Page 58
Standard Services per Bluetooth SIG	Page 58
Device Information Service (0x180A)	Page 58
Battery Service (0x180F)	Page 58
Weight Scale Service (0x181D)	Page 58
BLUETOOTH INTERFACE STANDARD PROTOCOLS	Page 59
Bluetooth Characteristic – Weight_Measurement: 0x2A9D	Page 59
Weight_Measurement: 0x2A9D	Page 59
Custom Services	Page 60
Detecto SMA Service (0x907a0000-8699-47dd-ab30-d7aad5f83e54)	Page 60
SMA Commands	Page 60
WI-FI AND BLUETOOTH SMA COMMANDS	Page 61
DISPLAY SCALE WI-FI AND BLUETOOTH SETTINGS	Page 63
ERROR AND OPERATION MESSAGES	Page 64
BEFORE YOU CALL SERVICE	Page 64
CARE AND CLEANING	Page 65
PARTS IDENTIFICATION	Page 66
Final Assembly	Page 66
Sonar HR Sub-Assembly	Page 67
Column Sub-Assembly	Page 68
Display Sub-Assembly	Page 69
Base Sub-Assembly	Page 70
STATEMENT OF LIMITED WARRANTY	Page 72

SPECIFICATIONS

Capacity:	600 lb x 0.2 lb / 1,000 lb x 0.5 lb 300 kg x 0.1 kg / 500 kg x 0.2 kg
Weighing/Height Units:	Pounds/Inch (lb, in) or Kilograms/Centimeters (kg, cm)
Platform Size:	17 in W x 17 in D x 1.5 in H (43 cm W x 43 cm D x 3.8 cm D)
Overall Dimensions:	17 in W x 18.5 in D x 88.5 in H (43 cm W x 47 cm D x 224.8 cm H)
Sonar Height Rod Measures:	24" (2') – 86" (7'2") x 0.2 in (60 cm – 218 cm) x 0.5 cm
Display Type:	3.2 in (diagonal) full color TFT display 320x240 resolution
Number of Characters:	Weight: 5 digits, 0.8 in (20 mm) high Height: 4 digits, 0.35 in (9 mm) high BMI: 3 digits, 0.35 in (9 mm) high
Touch Screen:	Resistive touch panel covering the display
Keys:	Mechanical switch type, Power, Zero, Lock/Release, ID, Cycle Display Mode, Menu, Print
Power Requirements:	Domestic models: <u>Included</u> 100 to 240 VAC 50/60Hz 12 VDC 1A wall plug-in UL/CSA listed AC power adapter (Cardinal part number 6800-1045) International models: <u>Included</u> 100 to 240 VAC 12 VDC 1A Multi Pin Input AC power adapter (Cardinal part number 6800-1047) <i>Optional: 12 "AA" cell Alkaline, Ni-Cad or NiMH batteries (not included)</i>
Operating Environment:	Operated Temperature Range: 14 to 104 °F (-10 to +40 °C) Humidity: 0 to 90% non-condensing
Communication Interfaces:	RS232, USB, Wi-Fi, and Bluetooth 5.0

Standard Features:

- Units Locking into LB or KG
- Dual Range Weight
- Auto Weight Lock Feature
- 8-Digit Numeric Patient ID
- Mother/Baby Function
- StableSENSE®¹ Adjustable Filtering
- Wi-Fi and Bluetooth 5.0
- 1 RS232 Serial Port
- 1 USB-B Port
- Sonar Height Rod

Optional Features:

- WACconnect, Welch Allyn® Interface

¹ StableSENSE® is a digital filter utilizing proprietary software algorithms to remove or greatly reduce changes in the weight display resulting from movement on the scale platform. StableSENSE® can be used with clinical scales to lessen the effects of the patient's movement or vibration on the scale. Any application affected by vibration or movement on the scale platform can benefit using StableSENSE®.

SITE PREPARATION REQUIREMENTS

The icon Digital Clinical Scale is a precision weight indicating instrument. As with any precision instrument, it requires an acceptable environment to operate at peak performance and reliability. This section is provided to assist you in obtaining such an environment.

Environmental

- For indoor use only.
- Suitable for dry environments only RH < 90% and non-condensing environments.
- NEVER allow scale to get wet.
- The scale meets or exceeds all certification requirements within a temperature range of 14 to 104 °F (-10 to +40 °C).

The scale should be placed out of direct sunlight and to provide adequate air circulation, keep the area around the scale clear.

Do not place the scale directly in front of a heating or cooling vent. Such a location will subject it to sudden temperature changes, which may result in unstable weight readings.

Ensure that the scale has good, clean AC power and is properly grounded. In areas subject to lightning strikes, additional protection to minimize lightning damage, such as surge suppressors, should be installed.

Electrical Power

The icon Digital Clinical Scale has been designed to operate from a 100 to 240 VAC 50/60Hz 12 VDC 1A wall plug-in UL/CSA listed AC power adapter. Note that a special order is not required for operation at 230 VAC.

- The socket-outlet supplying power to the scale should be near the scale and should be easily accessible.
- On installations requiring 230 VAC power, **it is the responsibility of the customer** to have a qualified electrician install the proper power adapter plug that conforms to national electrical codes and local codes and ordinances.

Electrical Noise Interference

To prevent electrical noise interference, make certain all air conditioning and heating equipment, lighting or other equipment with heavily inductive loads, such as welders, motors and solenoids are on circuits separate from the system. Many of these disturbances can seriously affect the operation of the system. These sources of disturbances must be identified and steps must be taken to prevent possible adverse effects on the system. Examples of available alternatives include isolation transformers, power regulators, uninterruptible power supplies, or simple line filters.

UNPACKING

Carefully remove the icon Digital Clinical Scale from the shipping carton and inspect it for any damage that may have taken place during shipment. *Keep and use the original carton and packing material for return shipment if it should become necessary.* The purchaser is responsible for filing all claims for any damages or loss incurred during transit. Remove all plastic wrapping, foam fillers and cardboard material from scale platform, display and other components. You should have the following components:

- ① Column with attached Display and Sonar Bracket
- ② Column Cover
- ③ Scale Base
- ④ Scale Base Cover
- ⑤ Sonar Height Rod
- ⑥ AC Power Adapter

ASSEMBLY

TOOLS REQUIRED:

3/16" Allen wrench

1. Place the scale base on a level floor.
2. Insert the column cover onto the column.
3. Position the column over the opening in the scale base and then plug the modular connector from the column into the socket in the scale base.

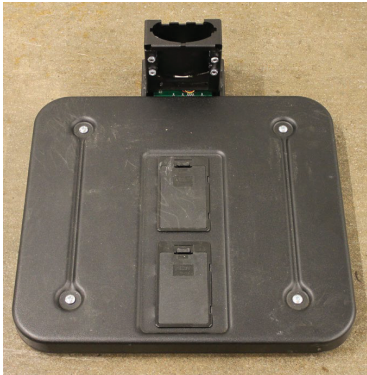

Step 1

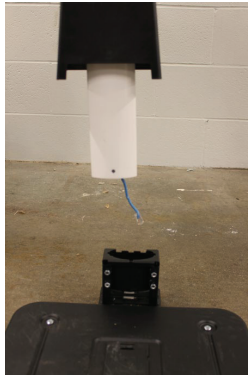

Step 2

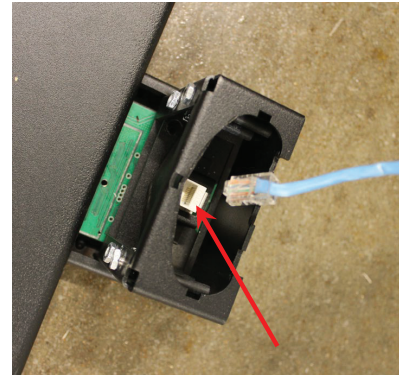

Step 3

4. Insert the column into the scale base.
5. Using the 3/16" Allen wrench, *evenly* tighten the (4) Allen head screws on the back of the scale base to secure column to scale base.

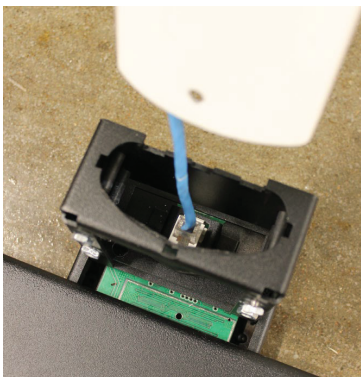

Step 4

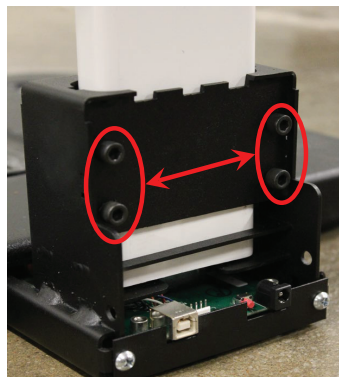

Step 5

IMPORTANT! The nuts on the front of the column opening in the scale base may turn as you are tightening the Allen head screws. *This is normal.* DO NOT use a wrench or other tool to hold the nut to keep it from turning.

6. Slide the column cover down onto the base. Note that you may have to pull the cover out slightly to clear the USB port and the AC power jack.
7. Place the scale base cover on the scale base and press down on both sides of the cover. Note that a clicking sound will occur when the cover is snapped in place.

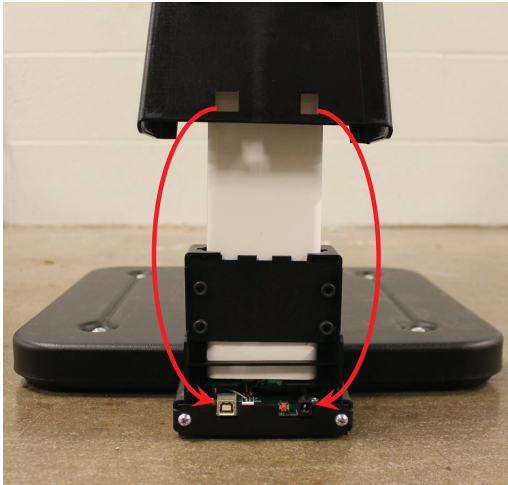

Step 6



Step 7

8. Remove the sonar bracket by pushing up from the bottom of the bracket (see Step 8a) until the screws are aligned with the large end of the slotted holes (see Step 8b) in the bracket and pull it away from the column. Set the sonar bracket aside.
9. Align the wire connector from the end of Sonar tube with the wire connector from the back of column and plug together.



Step 8a

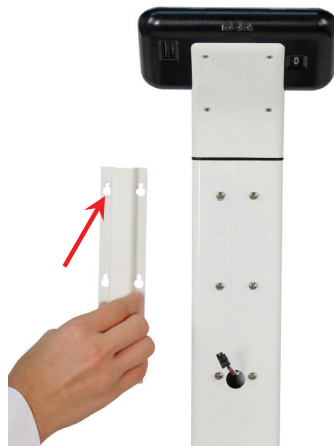

Step 8b



Step 9

10. Place the bracket over the sonar tube making sure the tube is completely down in the bracket.
11. Next, insert the cable and connector into the hole on the back of the column.
12. Aligning the large end of the slotted holes in the bracket with the screws in the column, (see Step 10 and Step 11) place the sonar tube on the back of the column and pull down to secure the sonar bracket to the column.



Step 10 and Step 11

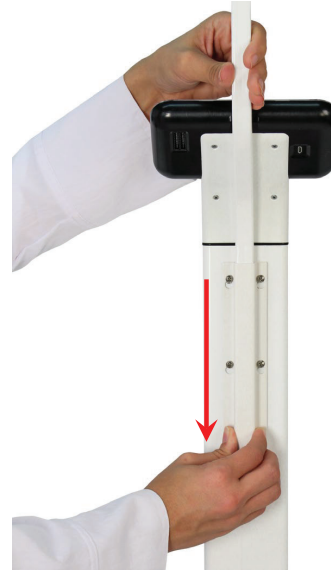

Step 12

13. The scale is now ready for operation.



NOTE: For instructions on powering the scale using the AC power adapter or for instructions on how to install batteries, refer to the INTERCONNECTIONS section of this manual.

INTERCONNECTIONS

The output and power connections to the scale are made on the rear of the scale base.

AC Power Adapter

To power the scale using the 12VDC wall plug-in UL/CSA listed AC power adapter, connect the plug from the adapter into the power jack on the back of the scale base and then plug the power adapter into the proper electrical outlet. On models requiring 230 VAC, it is the customer's responsibility to obtain the correct power adapter plug.

USB

The USB port on the scale is a device (or upstream) port and uses readily available cables with the industry standard "Micro-B" connector.

The USB port may be connected to a computer for transmission of weight and associated data to a PC-based EMR (electronic medical record) software program. The data can be transmitted on demand (pressing the ← key) or on receipt of a command from the computer.

Height Rod – Detecto Sonar Height Rod

The Detecto Sonar Height Rod connects to the scale by a snap-in modular connector socket. Insert the modular connector of the Sonar Height Rod into the socket on the back of the scale column it locks in place (a clicking sound will be heard when it is locked in place).

Batteries

The scale can use 12 "AA" size Alkaline, Ni-Cad or NiMH batteries (*not included*). You must first obtain and install batteries before operations can begin. Batteries are contained in two (2) battery holders inside the scale base. Access is via two (2) removable panels in the scale base, accessible after removing the scale platform cover.



CAUTION! The scale can be operated from Alkaline, Ni-Cad or NiMH batteries. All twelve (12) batteries must be of the same type. They must all be Alkaline, all Ni-Cad or all NiMH. **DO NOT** mix Alkaline and Ni-Cad or NiMH batteries.



NOTE: The icon scale does not have a battery charging circuit. Should you wish to use Ni-Cad or NiMH batteries, they must be fully charged before installing. When discharged, Ni-Cad or NiMH batteries must be removed and placed in an external charger to recharge.

Battery Status

The battery status will be displayed when batteries are installed. A number will be displayed in the upper right of the screen indicating the level of charge remaining in the batteries. For example, 100 = 100% charge, 75 = 75% charge, etc.

When the batteries are the point they need to be replaced (Alkaline) or recharged (NiCad or NiMH) and the battery voltage drops too low for accurate weighing, the scale will automatically shut off and you will be unable to turn it back on.

Using Alkaline Batteries

When the batteries are low enough that the scale turns off, remove the old batteries and replace with new ones.

Using NiCad or NiMH Batteries

When the batteries are low enough that the scale turns off, remove the discharged batteries and replace with fully charged ones. Place the discharged batteries in an external charger to recharge.

Battery Installation/Replacement

To install or remove the batteries, the following steps should be followed:

1. Make sure the AC power adapter is unplugged.
2. Remove the platform cover from the scale base.
3. Referring to Figure No. 1, locate the two (2) rectangular panels in the scale base.
4. To install or replace the batteries, first remove each battery holder cover by pushing in on the tab and lifting it up exposing the battery holders. See Figures No. 2 and 3.
5. If installing new batteries, proceed to step 6. If replacing the batteries, remove all 6 batteries from the battery holder and then proceed to step 6.
6. Referring to Figure No. 4, install six (6) "AA" size batteries in each holder, noting the polarity markings located in the battery holder.
7. After placing six (6) batteries in each holder, replace the battery covers.

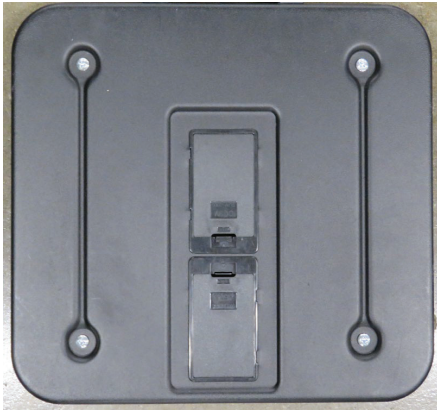

Figure No. 1

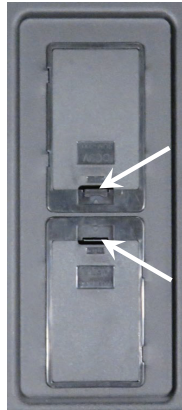



Figure No. 2



Figure No. 3



Figure No. 4

8. Install the platform cover on the scale base and press the  key.
9. If display turns on, batteries have been installed correctly. If not, remove the platform cover and then the battery covers and check for one or more improperly positioned batteries.
10. The scale is now ready for operation.

PLACING THE SCALE

- For indoor use only.
- Place the scale on a flat, level floor or low-cut carpet away from heating and cooling vents.
- Make certain the AC Power Adapter (if included) cord is out of the way of normal traffic to avoid a trip hazard.
- NEVER allow the scale to get wet.

Check to make certain the scale is level. The level indicator is located at the rear of the scale. If the scale is not level (the bubble will not be centered), position the scale as required to center the bubble and attain a level scale.

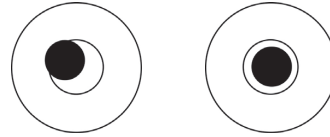

NOT LEVEL

LEVEL



NOTE: Any time the scale is moved or re-located, be sure to check the level bubble to ensure the scale is level before using.

WEIGHING UNITS/HEIGHT MEASUREMENT SELECTION

When the scale is turned on for the *first* time, it will display a prompt to select the weighing units/height measurement to use for your operation, LB/IN (pounds/inches) or KG/CM (kilograms/centimeters). The weighing units/height measurement selection can **ONLY** be made at this time and cannot be changed afterward. Make sure you select the correct weighing units/height measurement before proceeding.



WARNING!

Make sure you select the correct weighing units/height measurement. Once selected the weighing units/height measurement is permanent and cannot be changed.



1. Press  key to turn the scale on.
2. The scale display will show the software version for a few seconds, the Detecto logo briefly, and then change to a WARNING screen. This screen is displayed to inform and warn you that once you have made the weighing units/height measurement selection, it is PERMANENT and cannot be changed.



3. After reading and understanding the warning screen, press **OK** on the screen to continue.

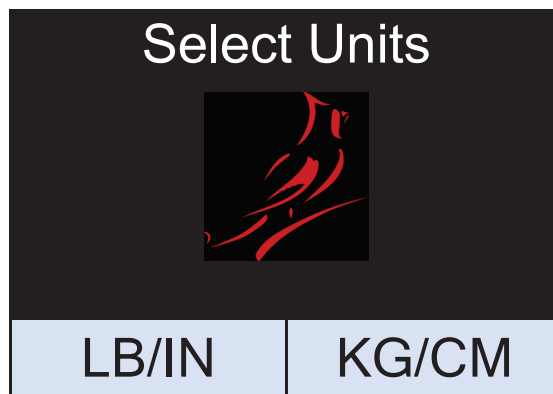

4. If weighing in pounds (LB) and measuring in inches (IN) is required for your operation, press the **LB/IN** key at the bottom left of the screen.
5. If your operation requires weighing in kilograms (KG) and measuring in centimeters (cm), press the **KG/CM** key on the bottom right of the screen.
6. Your icon Digital Clinical Scale is now ready for operation.

KEYPAD FUNCTIONS



DO NOT operate the keys or touchscreen with pointed objects (pencils, pens, etc.). Damage to keys or touchscreen resulting from this practice is **NOT** covered under warranty.



This is the **Power** key. With the scale off, pressing this key will apply power to the scale and turn on the display. If the scale is already on, pressing the key will turn it off.



This is the **Zero** key. Press and release this key to reset the display to zero. Note that when this key is pressed with weight on the scale platform, the display will zero the weight up to 100% of the scale capacity. When the weight is removed, the display will show a negative weight value. Press the $\Rightarrow 0 \Leftarrow$ key again to reset the display to zero.



This is the **MOTHER/BABY** key. It is used with the Mother/Baby Weighing feature to determine the weight of infants and toddlers held by an adult. This feature allows the adult to be weighed first, and then the adult and infant/child weighed with only the weight of the infant/child displayed.



This is the **Lock/Release** key. Press and release this key, or touch the weight readout on the display to cause the weight, height, and BMI to lock on the current values until the key is pressed again or the weight readout on the display is touched again. While the weight is locked, the weight status will change to LOCKED in order to denote that the weight is being held.



This is the **ID** key. Press and release this key to open the ID entry screen where you can use the touch screen to enter in a numeric ID. This ID is **NOT** used for tracking patient measurements. The ID that is entered is only transmitted out of the communication port when the \hookleftarrow key is pressed. To change or edit the ID, simply press the **ID** key again to return to the ID entry screen.



This is the **Display Mode** key. Press and release this key to cause the display to cycle between display modes: Weight/Height/BMI or Weight only.



This is the **Menu** key. Press and release this key to launch the Menu screen. The first screen that is displayed is the Settings Overview screen where you can see all of the settings at a glance. To continue into setup, touch the Setup key at the bottom right of the touch screen.



This is the **Enter** key. It serves two purposes. First, pressing and releasing this key is used to signal the completion of data entry and cause the scale to output the current date, time, weight, height, and BMI for data capture for EMR/EHR purposes. Note that the output options include Cardinal SMA, Welch Allyn, Tanita, or IEEE 11073-10415 formats.

Second, the **Enter** key is used as a Print key when using the Wi-Fi and Bluetooth features of the scale. Pressing and releasing the **Enter** key will signal the completion of data entry and cause the scale to output (print) the current date, time, weight, height, and BMI using the Wi-Fi and Bluetooth wireless transmitter.

ANNUNCIATORS

The annunciators are displayed on the Weight screen to show that the scale is in the mode corresponding to the annunciator label or that the status indicated by the label is active.

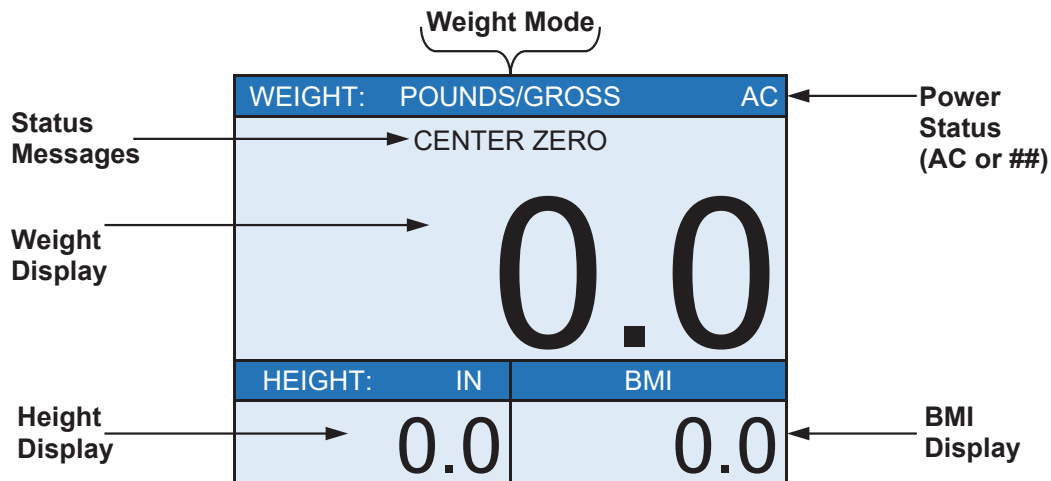

AC

This is shown on the Weight screen to indicate that the scale is powered by the AC adapter.

##

This is shown on the Weight screen to indicate that the scale is powered by batteries and the percentage of their remaining charge.

POUNDS/GROSS

This is shown on the Weight screen to indicate that the weight displayed is gross weight in pounds.



KILOGRAMS/GROSS

This is shown on the Weight screen to indicate that the weight displayed is gross weight in kilograms.

CENTER ZERO

This is shown on the Weight screen to indicate that the weight is within +/- 1/4 division of the center of zero.

LOCK

This is shown on the Weight screen to indicate that the scale is locked onto the displayed weight. In operation after obtaining a stable weight value, pressing the  key will cause the scale to lock onto the weight and turn on the annunciator. Pressing the  key a second time will unlock the display and turn off the annunciator.

IN

This is shown on the Weight screen to indicate that the displayed height measurement is in inches.

CM

This is shown on the Weight screen to indicate that the displayed height measurement is in centimeters.

BMI

This is shown on the Weight screen to indicate the calculated body fat (Body Mass Index).

OPERATION



ALWAYS assist the patient in stepping on and off the scale platform to ensure they do not fall. **NEVER** leave a patient unattended while they are on the scale platform. Failure to maintain control of the patient at all times can result in serious injury to the patient and/or you.

Zero Weight Display

1. In Gross Weight mode (POUNDS/GROSS or KILOGRAMS/GROSS shown on weight screen), if scale is not showing zero weight on weight screen press the ⇨0⇐ key.
2. Weight screen will return to zero (0.0) and CENTER ZERO will be displayed to show that the scale is ready for use.

Basic Weighing Operation

1. Press the ⏻ key to turn scale on.
2. If required, press the ⇨0⇐ key to zero weight screen.
3. Assist patient on scale
4. When weight is stable, a beep will sound, weight reading will automatically lock and AUTO LOCK will be displayed. Note that the amount of time the reading will hold is dependent upon the Auto Locking setting in Setup. **NOTE:** If more time is needed, press the 🔒 key to hold the locked weight reading.
5. Read weight display.
6. If “Auto” has been selected for the **Print:** setting in Setup, the scale will output EMR/EHR data when the weight is stable.



If “Manual” has been selected for the **Print:** setting in Setup, press the ↵ key to output EMR/EHR data when the weight is stable.
7. Assist patient off scale.

Basic Weighing Operation with ID – (No BMI)

1. Press the ⏻ key to turn scale on.
2. If required, press the ⇨0⇐ key to zero weight screen.
3. Press the 👤 key.
4. Display will change to show PATIENT ID screen.
5. Using numeric keys, enter up to an 8-digit numeric identification number.
6. Press the **Save** key.
7. Assist patient on scale
8. When weight is stable, a beep will sound, weight reading will automatically lock and AUTO LOCK will be displayed. Note that the amount of time the reading will hold is dependent upon the Auto Locking setting in Setup. **NOTE:** If more time is needed, press the 🔒 key to hold the locked weight reading.
9. Read weight display.
10. If “Auto” has been selected for the **Print:** setting in Setup, the scale will output EMR/EHR data when the weight is stable.

If “Manual” has been selected for the **Print:** setting in Setup, press the ↵ key to output EMR/EHR data when the weight is stable.
11. Assist patient off scale.

Body Mass Index (BMI) Operation – (No ID) (Weight, Measure Height, and Calculate BMI)

1. Press the  key to turn scale on.
2. If required, press the  key to zero weight screen.
3. Assist patient onto scale.



NOTE: In order to obtain an accurate height measurement, instruct patient to look straight ahead and not down at scale display.

4. When weight is stable, a beep will sound, weight reading will automatically lock and AUTO LOCK will be displayed. Note that the amount of time the reading will hold is dependent upon the Auto Locking setting in Setup. **NOTE:** If more time is needed, press the  key to hold the locked weight reading.
5. Scale will have completed measuring patient's height and calculating their BMI.
6. Read weight, height and BMI displayed.
7. If "Auto" has been selected for the **Print:** setting in Setup, the scale will output EMR/EHR data when the weight is stable.

If "Manual" has been selected for the **Print:** setting in Setup, press the  key to output EMR/EHR data when the weight is stable.

8. Assist patient off scale.

Body Mass Index (BMI) Operation with ID (Weight, Measure Height, and Calculate BMI)

1. Press the  key to turn scale on.
2. If required, press the  key to zero weight screen.
3. Press the  key.
4. Display will change to show PATIENT ID screen.
5. Using numeric keys, enter up to an 8-digit numeric identification number.
6. Press the **Save** key.
7. Assist patient onto scale.



NOTE: In order to obtain an accurate height measurement, instruct patient to look straight ahead and not down at scale display.

8. When weight is stable, a beep will sound, weight reading will automatically lock and AUTO LOCK will be displayed. Note that the amount of time the reading will hold is dependent upon the Auto Locking setting in Setup. **NOTE:** If more time is needed, press the  key to hold the locked weight reading.
9. Scale will have completed measuring patient's height and calculating their BMI.
10. Read weight, height and BMI displayed.
11. If "Auto" has been selected for the **Print:** setting in Setup, the scale will output EMR/EHR data when the weight is stable.

If "Manual" has been selected for the **Print:** setting in Setup, press the  key to output EMR/EHR data when the weight is stable.





12. Assist patient off scale.

Body Mass Index (BMI) Operation (Using Previously Measured Height)

1. Press the  key to turn scale on.
2. If required, press the  key to zero weight screen.
3. Press the **HEIGHT** on display screen.
4. If POUNDS/INCHES was selected for **Weighing/Height Units**, the display will change to show HEIGHT IN INCHES on screen.
 - a. Use numeric keys to enter up to 3 digits and decimal point (#.#) for height in inches, and then press the **Save** key.
5. If KILOGRAMS/CENTIMETERS was selected for **Weighing/Height Units**, the display will change to show HEIGHT IN CENTIMETERS on screen.
 - a. Use numeric keys to enter up to 2 digits and decimal point (#.#) for height in centimeters, and then press the **Save** key.
6. Assist patient onto scale.
7. When weight is stable, a beep will sound, weight reading will automatically lock and AUTO LOCK will be displayed. Note that the amount of time the reading will hold is dependent upon the Auto Locking setting in Setup. **NOTE:** If more time is needed, press the  key to hold the locked weight reading.
8. Scale will have completed measuring patient's height and calculating their BMI.
9. Read weight, height and BMI displayed.
10. If "Auto" has been selected for the **Print:** setting in Setup, the scale will output EMR/EHR data when the weight is stable.

If "Manual" has been selected for the **Print:** setting in Setup, press the  key to output EMR/EHR data when the weight is stable.
11. Assist patient off scale.

Body Mass Index (BMI) Operation with ID (Using Previously Measured Height)

1. Press the  key to turn scale on.
2. If required, press the  key to zero weight screen.
3. Press the   key.
4. Display will change to show PATIENT ID screen.
5. Using numeric keys, enter up to an 8-digit numeric identification number.
6. Press the **Save** key.
7. Press the **HEIGHT** on display screen.
8. If POUNDS/INCHES was selected for **Weighing/Height Units**, the display will change to show HEIGHT IN INCHES on screen.
 - a. Use numeric keys to enter up to 3 digits and decimal point (#.#) for height in inches, and then press the **Save** key.
9. If KILOGRAMS/CENTIMETERS was selected for **Weighing/Height Units**, the display will change to show HEIGHT IN CENTIMETERS on screen.
 - a. Use numeric keys to enter up to 2 digits and the decimal point (#.#) for height in centimeters, and then press the **Save** key.
10. Assist patient onto scale.
11. When weight is stable, a beep will sound, weight reading will automatically lock and AUTO LOCK will be displayed. Note that the amount of time the reading will hold is dependent upon the Auto Locking setting in Setup. **NOTE:** If more time is needed, press the  key to hold the locked weight reading.
12. Scale will have completed calculating patient's BMI.
13. Read weight and BMI displayed.
14. If "Auto" has been selected for the **Print:** setting in Setup, the scale will output EMR/EHR data when the weight is stable.

If "Manual" has been selected for the **Print:** setting in Setup, press the  key to output EMR/EHR data when the weight is stable.
15. Assist patient off scale.

MOTHER/BABY WEIGHING





ALWAYS assist the mother alone, and when holding the baby/child in stepping on and off the scale platform to ensure they do not fall.





NEVER leave the mother or mother holding the baby/child unattended while they are on the scale platform. Failure to maintain control of the mother or mother holding the baby/child at all times can result in serious injury to the mother or mother holding the baby/child and/or you.

The Mother/Baby Weighing feature can be used to determine the weight of infants and toddlers held by an adult. Note that for accurate weighing, the child should always be weighed with the same adult whose initial weight was determined. In addition, the adult's weight should not change, for example, by removing or adding an item of clothing.

The Mother/Baby Weighing procedure is as follows:

1. Press  key to turn the scale on.
2. If required, press $\Rightarrow 0 \Leftarrow$ key to zero weight display.
3. Assist the mother onto the scale.
4. When the weight is stable, a beep will sound, the weight reading will automatically lock, AUTO LOCK will be displayed, and the mother's weight will be displayed.

Note that the amount of time the reading will hold is dependent upon the Auto Locking setting in Setup. **NOTE:** If more time is needed, press the  key to hold the locked weight reading.

5. Press the  key.
6. The displayed weight will change to show 0.0, and BABY will be displayed on the screen instead of GROSS.
7. Assist the mother off the scale.
8. After the mother is holding the baby/child, assist them back onto the scale.
9. When the weight is stable, a beep will sound, the weight reading will automatically lock, AUTO LOCK will be displayed, and the baby/child's weight will be displayed.
Note that the amount of time the reading will hold is dependent upon the Auto Locking setting in Setup. **NOTE:** If more time is needed, press the  key to hold the locked weight reading.
10. Read and record the baby/child's weight displayed.
11. To turn off the Mother/Baby Weighing feature, press the  key or press the  key to turn the scale off.
12. Assist the mother holding the baby/child off the scale.



NOTE: If the weight on the scale is less than 40 lb (18.1 kg), pressing the **ZERO** key will zero the scale, and the scale will not enter the Mother/Baby Weighing mode.

SCALE SETUP

Your icon Digital Clinical Scale has been pre-configured at the factory and should not require changes for use in most applications. However, if the factory settings do not meet the requirements of your operation, the following describes the setup process for your scale.



NOTE: The keypad and touchscreen are not to be operated with pointed objects (pencils, pens, fingernails, etc.). Damage to the keypad or touchscreen resulting from this practice will NOT be covered under warranty.

Menu Functions

After pressing the **Menu** key to enter Scale Setup, the first screen of the menu is a Settings Overview screen where all of the settings can be reviewed at a glance. The Audit Trail Counters for the metrological settings and the non-metrological settings are available for review on this screen as well. Each prompt in the menu screens will show the current setting next to the prompt to easily identify what the current setting for that parameter is.

Settings Keys

1. Press the **Sonar** key to disable or calibrate the sonar height rod, or to set a new height in *centimeters* from the scale platform to the bottom of the sonar sensor. Proceed to the **SONAR CALIBRATION** section of this manual.
2. Press the **Exit** key to exit Setup and return to the Weight screen.
3. Press the **Setup** key on the Settings Overview screen to enter into the scale setup.
4. Press the >>> key on the bottom right of the Settings screen to advance to the next menu page.
5. Press the <<< key at the bottom left of the Settings screen to return to the previous menu page.

To Enter Setup

1. Press the  key to turn the scale on.
2. The scale will show the Detecto logo briefly and then change to the Weight screen.
3. With the Weight screen displayed, press the **Menu** key.
4. The display will change to show the Settings Overview 1 screen.

SETTINGS OVERVIEW 1		>>>
Revision 1.00.09, Display Rev. 1.0.18		
Audit Trail -- Cal=4, Cfg=2		
Range 1: 600.0 x 0.2 -- 2: 1000.0 x 0.5		
Weight Units=lb	Height Units=in	
Auto Lock=5 s	Sonar Ht=221.5 cm	
Motion=3 div.	Filter=Off	
OIML=No	ZeroTrack=10/2 d	
USB: SMA	Gravity=0.000000	
Power up zero=No		
Sonar	Exit	Setup

- Press >>> on top right of touchscreen to advance to the Settings Overview 2 screen.
- Press the **Exit** key to exit Setup and return to the Weight screen.
- Press the **Setup** key to advance to the Password screen and proceed with scale setup.

To Enter Setup, Cont.

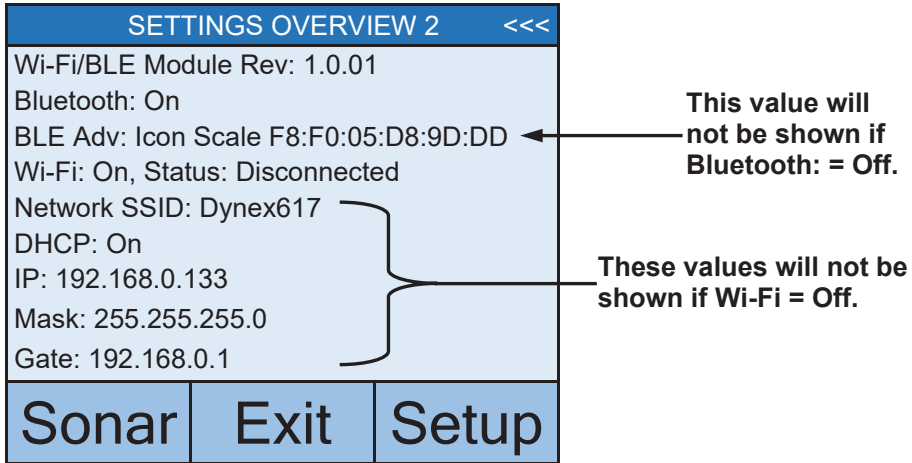

- Press <<< on top right of touchscreen to return to the Settings Overview 1 screen.
 - Press the **Exit** key to exit Setup and return to the Weight screen.
 - Press the **Setup** key to advance to the Password screen and proceed with scale setup.
5. After pressing **Setup** on the touchscreen, the display will change to show the ENTER PASSCODE screen.

ENTER PASSCODE				
Enter passcode to access settings. Press CANCEL to exit.	1	2	3	
	4	5	6	
	7	8	9	
SAVE	CANCEL	0	.	DEL

6. Using the 10-key on the touchscreen, enter 64870 and then press the **Save** key.
7. The scale is now ready for setup and calibration

Settings Page 1

SETTINGS		PAGE 1
Model: Icon		
Date: 11/6/2019		
Time: 12:24:44		
Language: English		
<<<	Exit	>>>

Model:

This will change the default settings and operation of the scale. For example, select “Icon” as the model in order to use the stand-up type scale with the sonar height measurement.

Touch this key to open the model selection screen. Using the numeric keys, enter a new setting, and then press the Save key.

Allowable settings are: 0 = icon, 1 = Wheelchair, 2 = Other, 3 = Dialysis

Date:

Touching this key allows entering the date, starting with the year. After pressing **Date:**, the screen will show “Key in the Year and press SAVE”.

Year

Enter the 4-digits (YYYY) for the year and then press the **Save** key.

Month

Enter the 2-digits (MM) for the month and then press the **Save** key.

Day

Enter the 2-digits (DD) for the day and then press the **Save** key.

Time:

Touching this key allows entering the time starting with the hour. After pressing **Time:**, the screen will show “Key in the Hour HH”.

Hour

Enter the 2-digits (HH) for the hour and then press the **Save** key.

Minute

Enter the 2-digits (MM) for the minute and then press the **Save** key.

Second

Enter the 2-digits (SS) for the seconds and then press the **Save** key.

Language:

This will change the language for the Setup and Operation screens of the scale.

Touch this key to open the language selection screen. Using the numeric keys, enter a new setting, and then press the **Save** key.

Allowable settings are: 0 = English, 1 = Spanish, 2 = German, 3 = French

- Press the >>> key to advance to the Settings Page 2.
- Press the <<< key to return to the Settings Overview screen.
- Press the **Exit** key to exit Setup and return to the Weight screen.

Settings Page 2

SETTINGS		PAGE 2
OIML: No		
Units: lb, in		
Filter Mode: 0		
Zero Tracking: 10		
<<<	Exit	>>>

OIML:

Touching this key will toggle the OIML setting to Yes or No. **NOTE:** This setting should be enabled for all EU models to comply with regulations.

Allowable settings for OIML are: Yes or No.

Units:

This is for reference only. The weighing/height units selection can **ONLY** be made when the scale is turned on for the *first* time. At that time, a prompt will be displayed to select the weighing/height units to use, pounds/inches (lb/in) or kilograms/centimeters (kg/cm). Once the weighing/height units has been set, it cannot be changed.

Refer to the WEIGHING UNITS/HEIGHT MEASUREMENT section of this manual.

Filter Mode:

Pressing this key will open the weight filtering screen. This will allow you to set the amount of digital filtering being applied to the scale. Using the numeric keys, enter a new setting, and then press the **Save** key.

Allowable settings are: 0 = Off, 1 = Minimal, 2 = Moderate, and 3 = Maximum

Zero Tracking:

Touching this key will open the zero-tracking screen. This will allow you to set the number of half (1/2) divisions that the scale will attempt to maintain zero. Using the numeric keys, enter a new setting, and then press the **Save** key.

Allowable settings for Zero Tracking are: 0 – 100.

- Press the >>> key to advance to the Settings Page 3.
- Press the <<< key to return to the Settings Page 1.
- Press the **Exit** key to exit Setup and return to the Weight screen.

Settings Page 3

SETTINGS		PAGE 3
Capacity 1: 600.0		
Capacity 2: 1000.0		
Interval 1: 2		
Interval 2: 5		
<<<	Exit	>>>

Capacity 1:

Touching this key will open the capacity screen. This will allow you to set the capacity of the first range. Using the numeric keys, enter a new setting, and then press the **Save** key.

The first range of the scale should be set to 600.0.

Capacity 2:

Touching this key will open the capacity entry screen for the second weight range. This setting **MUST** be greater than Capacity 1 if used. Using the numeric keys, enter a new setting, and then press the **Save** key.

The second range of the scale should be set to 1000.0.

NOTE: To disable the second weight range, set Capacity 2 to a setting of (0) zero.

Interval 1:

Touching this key will open the interval entry screen. This will allow you to set the scale interval for the first range. Using the numeric keys, enter a new setting, and then press the **Save** key.

Allowable settings for Interval 1 are 1, 2, or 5.

Interval 2:

If a second range capacity has been set, then Interval 2 will be used as the interval of the second weight range if enabled (see Capacity2). Using the numeric keys, enter a new setting, and then press the **Save** key.

Allowable settings for Interval 2 are: 1, 2, or 5.

- Press the >>> key to advance to Settings Page 4.
- Press the <<< key to return to Settings Page 2.
- Press the **Exit** key to exit Setup and return to the Weight screen.

Settings Page 4

SETTINGS		PAGE 4
Decimal 1: 1		
Decimal 2: 1		
Motion Range: 3		
Gravity: 0.000000		
<<<	Exit	>>>

Decimal 1:

Touching this key will open the decimal entry screen. This will allow you to set the decimal point precision for the first weight range. Using the numeric keys, enter a new setting, and then press the **Save** key.

Allowable settings for Decimal 1 are: 0 – 3.

Decimal 2:

Touching this key will open the decimal entry screen. This will allow you to set the decimal point precision for the second weight range if enabled (see Capacity2). Using the numeric keys, enter a new setting, and then press the **Save** key.

Allowable settings for Decimal 2 are: 0 – 3.

Motion Range:

Touching this key will open the motion range entry screen. This will allow you to set the number of scale divisions of movement that will be allowed for stable. Using the numeric keys, enter a new setting, and then press the **Save** key.

Allowable settings for Motion Range are: 0 – 20.

Gravity:

Gravity compensation accounts for latitudes and elevations that are different from where the scale was calibrated at. In order to calculate the setting for this parameter, use the gravitational constant of the location where the scale was calibrated divided by the gravitational constant of where the scale will be installed:

$$\frac{\text{Gravitational Constant (Calibration location)}}{\text{Gravitational Constant (Operation location)}} = \text{setting}$$

This should give you a setting close to 1 that you can enter in to compensate for variation in gravity due to elevation/latitude.

Touching this key will open the gravity compensation entry screen. Using the numeric keys, enter a new setting, and then press the **Save** key.

NOTE: If you do not wish to use the compensation feature, it must be set to 0 (zero) in order to disable it.

- Press the >>> key to advance to the Settings Page 5.
- Press the <<< key to return to the Settings Page 3.
- Press the **Exit** key to exit Setup and return to the Weight screen.

Settings Page 5

SETTINGS		PAGE 5
Calibrate Scale		
Load Cell Trim		
Power up Zero: No		
Auto Locking: 5 s		
<<<	Exit	>>>

Calibrate Scale

Touching this key will allow for calibration of the scale. Refer to the **CALIBRATION** section of this manual for instructions to select the calibration mode and how to perform calibration.

Load Cell Trim

Touching this key will allow for trimming (adjusting the output of) the load cells in the scale. Refer to the **LOAD CELL TRIM** section of this manual for instructions on how to trim the load cells.

Auto Locking:

This setting is used by the scale to hold a stable patient weight for a desired amount of time. For example, if a setting of 5 seconds is used, then when the scale locks onto a stable patient weight, it will remain locked for 5 seconds before automatically releasing the weight.

Touching this key will open an entry screen for the auto-locking feature of the scale. The setting entered is a time in seconds. Using the numeric keys, enter a new setting, and then press the **Save** key.

Allowable settings for Auto Locking are: 0 to 60.

Power up Zero:

Touching this key will toggle the power up zeroing of the scale to Yes or No. If enabled, this will cause the scale to attempt to zero the scale on power up.

Allowable settings for Power up Zero are: Yes or No.

- Press the >>> key to advance to the Settings Page 6.
- Press the <<< key to return to the Settings Page 4.
- Press the **Exit** key to exit Setup and return to the Weight screen.

Settings Page 6

SETTINGS		PAGE 6
Serial Type: Pass		
USB: SMA		
Print: Manual		
<<<	Exit	>>>

Serial Type:

Touch this key to open the serial type selection screen to change the operation of the Serial RS232 port. Using the numeric keys, enter a new setting, and then press the **Save** key.

Allowable settings are: 0 = pass through printing, 1 = Spot LXi¹

If Spot LXi was selected for Serial Type, the scale will automatically interface to a Welch-Allyn Spot LXi interface device to transmit weight data.

USB:

Touch this key to open the USB port selection screen to change the operation of the USB port. Using the numeric keys, enter a new setting, and then press the **Save** key.

Allowable settings are: 0 = SMA, 1 = Welch Allyn¹, 2 = PHDC

- If SMA was selected, and the scale is connected to a computer for transmission of weight data to a PC-based electronic medical record software program, it will transmit a single set of weight data each time a SMA weight request <LF>W<CR> is received.
- If Welch Allyn was selected, the scale will automatically transmit data to a Welch Allyn CVSM Device as soon as a stable weight is obtained.
- If PHDC (Personal Healthcare Device Class) was selected, the scale will transmit data using the CEN ISO/IEEE 11073 Medical / Health Device Communication Standard.

Print:

Touching this key will toggle the Print setting to Auto or Manual for printing (outputting data) when a stable weight has been obtained on the scale.

- If "Auto" is selected, the scale will automatically print (output data) as soon as a stable weight is obtained.
- If "Manual" is selected, after a stable weight has been obtained, you must press the  key to print (output data).

Allowable settings for Print are: 0 = Manual, 1 = Auto

- Press the >>> key to advance to the Settings Page 7.
- Press the <<< key to return to the Settings Page 5.
- Press the **Exit** key to exit Setup and return to the Weight screen.

¹ Requires device to have an activated license. Must purchase Detecto WACONNECT.

Settings Page 7

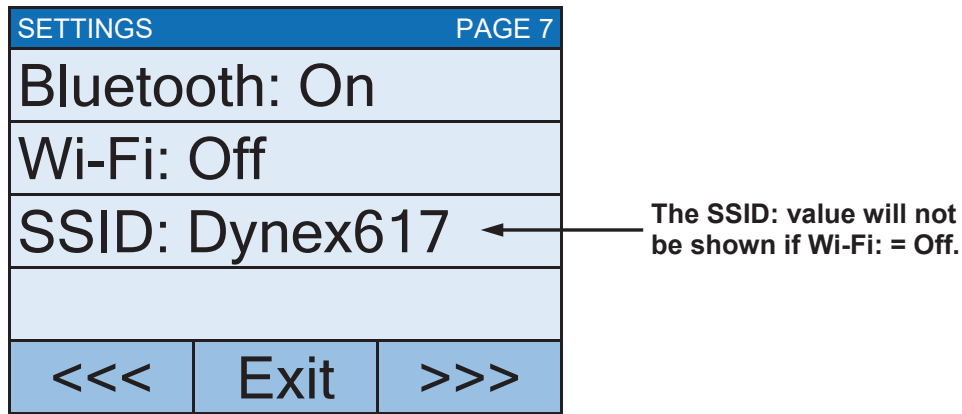

Bluetooth:

Touch this key to open a selection screen to turn the Bluetooth 5.0 wireless transmitter On or Off. This setting should be On if pairing to a Bluetooth-capable device is desired. Using the numeric keys, enter a new setting, and then press the **Save** key.

Allowable settings for Bluetooth are: 0 = Off, 1 = On

Wi-Fi:

Touch this key to open a selection screen to turn the Wi-Fi wireless transmitter On or Off. This setting should be On if interfacing through a Wi-Fi network is desired. Using the numeric keys, enter a new setting, and then press the **Save** key.

Allowable settings for Wi-Fi are: 0 = Off, 1 = On



NOTE: If the setting for **Wi-Fi: = Off**, you will not see the SSID: setting and the >>> key on the touchscreen to advance to Settings Page 8.

SSID:

This will show you the current SSID of the Wi-Fi network that is saved in memory for the Icon to connect to.

Touching this key will prompt you to CLEAR SSID. Press 1 on the entry screen, and then press the **Save** key to clear the Wi-Fi credentials.

- Press the >>> key to advance to the Settings Page 8.
- Press the <<< key to return to the Settings Page 6.
- Press the **Exit** key to exit Setup and return to the Weight screen.

Settings Page 8

SETTINGS		PAGE 8
DHCP: On		
IP: 192.168.0.133		
NM: 255.255.255.0		
GW: 192.168.0.1		
<<<	Exit	

The settings for NM:
and GW: will not be
shown if DHCP: = On.

DHCP:

Touching this key will open an entry screen to allow you to select the DHCP setting. This setting selects whether the Wi-Fi wireless transmitter will use a dynamic IP address assigned by a DHCP server or a static IP address. Consult with your network administrator for the proper selection. Using the numeric keys, enter a new setting, and then press the **Save** key.

Allowable settings for DHCP are: 0 = Static IP (Off), 1 = DHCP (On)



NOTE: If the setting for **DHCP: = Off**, the settings for **NM:** (Netmask) and **GW:** (Gateway Address) will be shown on the touchscreen.

NM: (Netmask)

Touching this key will open an entry screen to allow you to enter the Wi-Fi network Netmask for the network the scale will be connected to. Using the numeric keys, enter a new setting, and then press the **Save** key.

The format for the Netmask is: ### . ### . ### . # (e.g., 255.255.255.0).

IMPORTANT! The Netmask of the scale should match the Netmask of the other computers on your network.

GW: (Gateway Address)

Touching this key will open an entry screen to allow you to enter the Wi-Fi network Gateway Address for the network the scale will be connected to. Using the numeric keys, enter a new setting, and then press the **Save** key.

The format for the Gateway Address is: #, #, #, # (e.g., 192.168.0.1).

- Press the <<< key to return to the Settings Page 7.
- Press the **Exit** key to exit Setup and return to the Weight screen.

SONAR CALIBRATION

The Sonar Height Rod on your icon Digital Clinical Scale has been pre-configured and calibrated at the factory and should not require changes. However, if the factory settings do not meet the requirements of your operation, the following describes the process to calibrate the sonar height rod, change the height setting, or disable the Sonar Height Rod.

To Enter Sonar Calibration

1. Press the  key to turn the scale on.
2. The scale will show the Detecto logo briefly and then change to the Weight screen.
3. With the Weight screen displayed, press the **Menu** key.
4. The display will change to show the Settings Overview 1 screen.

SETTINGS OVERVIEW 1 >>>		
Revision 1.00.09, Display Rev. 1.0.18		
Audit Trail -- Cal=4, Cfg=2		
Range 1: 600.0 x 0.2 -- 2: 1000.0 x 0.5		
Weight Units=lb	Height Units=in	
Auto Lock=5 s	Sonar Ht=221.5 cm	
Motion=3 div.	Filter=Off	
OIML=No	ZeroTrack=10/2 d	
USB: SMA	Gravity=0.000000	
Power up zero=No		
Sonar	Exit	Setup

5. Touch the **Sonar** key.
6. The display will change to a selection screen to disable or calibrate the sonar height rod, or to set a new height from the scale platform to the bottom of the sonar sensor.

CALIBRATE SONAR				
0.0		1	2	3
0 = Disable 1 = Calibrate Or enter a new HEIGHT in cm.		4	5	6
		7	8	9
SAVE	CANCEL	0	.	DEL

To Disable the Sonar Height Rod

1. Press the 0 key and then press the **Save** key.
2. The display will change to show the Settings Overview 1 screen.
3. The sonar height rod is now disabled.
4. Press the **Exit** key to return to the Weight screen.

To Calibrate the Sonar Height Rod

1. Press the 1 key and then press the **Save** key.
2. The display will show “Clear” for approximately four seconds indicating you should step away from the sensor at a distance of at least 6 feet as it prepares to calibrate.

NOTE: Movable objects that might interfere with the sound waves of the sensor should be removed from a 6-foot radius. Objects that are not easily movable (walls, a desk, large heavy objects that stay in one-spot) can be left in place. These larger objects will be masked away in the calibration process.

CALIBRATE SONAR				
Clear 0 = Disable 1 = Calibrate Or enter a new HEIGHT in cm.		1	2	3
		4	5	6
		7	8	9
SAVE	CANCEL	0	.	DEL

3. After approximately four seconds, the display will briefly show “Working” as the sonar sensor calibrates. At this time, the sensor is recording data on its surroundings and auto-detecting the distance to the scale platform.

NOTE: Calibration will take approximately ten seconds.

CALIBRATE SONAR				
Working 0 = Disable 1 = Calibrate Or enter a new HEIGHT in cm.		1	2	3
		4	5	6
		7	8	9
SAVE	CANCEL	0	.	DEL

4. When calibration is complete, the scale will beep, and then the display will return to the Settings Overview 1 screen.
5. The sonar height rod has now been calibrated to its surroundings.
6. Press the **Exit** key to return to the Weight screen.



IMPORTANT! Any time the scale is moved to a different location, it should be recalibrated.

To Enter A New Height

The height in centimeters from the scale platform to the bottom of the sonar height rod sensor has been pre-configured at the factory and should not require changes. If an additional mat or other covering has been added to the scale platform, the new distance, in *centimeters* from the scale platform to the bottom of the sonar sensor **must be** measured and entered as accurately as possible to guarantee accurate height measurements from the sonar height rod.

CALIBRATE SONAR				
0.0 0 = Disable 1 = Calibrate Or enter a new HEIGHT in cm.		1	2	3
		4	5	6
		7	8	9
SAVE	CANCEL	0	.	DEL

1. Using the numeric keys, enter the new height in *centimeters*, (including the decimal point if needed).
2. Press the **Save** key.
3. The display will change to show the Settings Overview 1 screen.
4. Press the **Exit** key to return to the Weight screen.



IMPORTANT! If a new height has been entered (distance from scale platform to bottom of the sonar sensor), the scale should be recalibrated.

SCALE CALIBRATION

Calibration Modes

The icon Digital Clinical Scale has four modes that can be used to perform calibration. The modes are as follows:

1 = SmartCal®

SmartCal is the most precise method of calibration. It requires that a calibrated load be placed over each load cell of the scale platform only once. In this method, the indicator will be able to derive calibration constants which will be used to combine information from each load cell into scale weight.

During SmartCal, the indicator will prompt for the test load to be applied over a particular load cell. With a scale that has four load cells, the order will simply be cell 1, cell 2, cell 3 and cell 4. This order is used so that calibration can be done using a test weight with a minimal amount of maneuvering required. Refer to the illustration below.

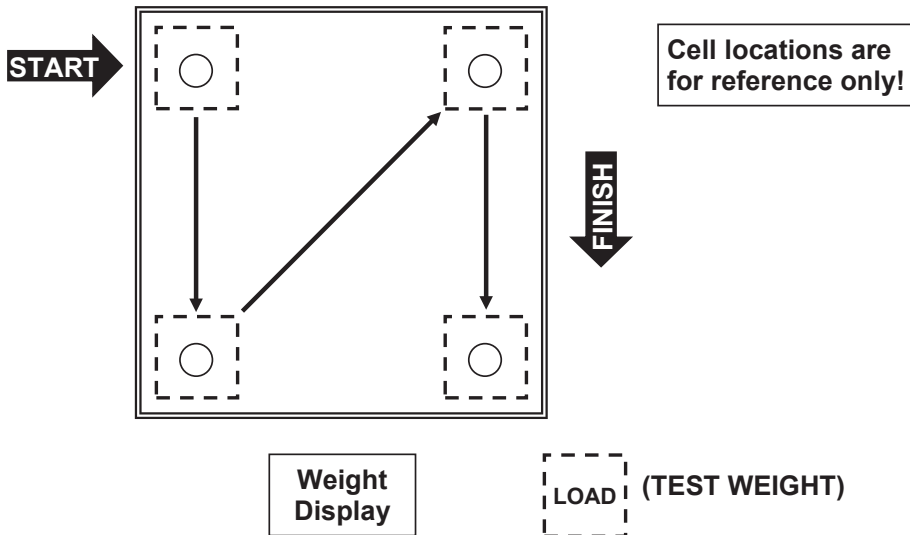

Load Cell and Load Placement

2 = Two Calibration Points

This is a standard calibration method requiring an empty scale and one weight. This method uses two calibration points (an empty scale and the full test load on the scale) to establish a zero (no load) calibration value and to span the indicator.

3 = Three Calibration Points

This method requires an empty scale, two weights and uses three calibration points, (an empty scale, half the test load and the full test load on the scale). The three points correspond to zero (no load) weight, mid-point weight and test load (weight).

4 = Four Calibration Points

This method requires an empty scale, three weights and uses four calibration points, (an empty scale, one fourth the test load, half the test load and the full test load on the scale). The four points correspond to zero weight, quarter-point weight, mid-point weight and test load (weight).

To Enter Calibration

1. With the scale turned on and the Weight screen displayed, press the **Menu** key.
2. The display will change to show the Settings Overview 1 screen.

SETTINGS OVERVIEW 1 >>>		
Revision 1.00.09, Display Rev. 1.0.18		
Audit Trail -- Cal=4, Cfg=2		
Range 1: 600.0 x 0.2 -- 2: 1000.0 x 0.5		
Weight Units=lb	Height Units=in	
Auto Lock=5 s	Sonar Ht=221.5 cm	
Motion=3 div.	Filter=Off	
OIML=No	ZeroTrack=10/2 d	
USB: SMA	Gravity=0.000000	
Power up zero=No		
Sonar	Exit	Setup

3. Press **Setup** on the touchscreen.
4. The display will change to show the ENTER PASSCODE screen.

ENTER PASSCODE				
Enter passcode to access settings. Press CANCEL to exit.		1	2	3
		4	5	6
		7	8	9
SAVE	CANCEL	0	.	DEL

5. Using the 10-key on the touchscreen, enter 64870 and then press the **Save** key.
6. The display will change to show the Settings Page 1 screen.

SETTINGS	PAGE 1
Model: Icon	
Date: 11/6/2019	
Time: 12:24:44	
Language: English	
<<<	Exit >>>

7. Press the >>> key to advance to the Settings Page 5 screen.

To Enter Calibration, Cont.

SETTINGS		PAGE 5
Calibrate Scale		
Load Cell Trim		
Power up Zero: No		
Auto Locking: 5 s		
<<<	Exit	>>>

8. Select **Calibrate Scale** from the Settings Page 5 screen.
9. The display will change to show the “Number of Points” screen.

CALIBRATE SCALE				
2 Number of points at which the scale will be calibrated. 1 = SmartCal	1	2	3	
	4	5	6	
	7	8	9	
SAVE	CANCEL	0	.	DEL

10. With the “Number of Points” screen displayed, select 1, 2, 3, or 4 on the touchscreen and then press the **Save** key.

1 = SmartCal Calibration

(calibrated load placed over each load cell only once)

2 = Two Calibration Points

(empty scale and full test load)

3 = Three Calibration Points

(empty scale, half test load, and full test load)

4= Four Calibration Points

(empty scale, one fourth test load, half test load, and full test load)

11. Proceed to next sections of the manual for the type of calibration selected.

1 = SmartCal®

1. With the “Number of Points” screen displayed, press the 1 key on the touchscreen and then press the **Save** key.

CALIBRATE SCALE				
1 Number of points at which the scale will be calibrated. 1 = SmartCal	1	2	3	
	4	5	6	
	7	8	9	
SAVE	CANCEL	0	.	DEL

2. The display will change to show “Enter the known test weight”. Enter the value for the test weight and then press the **Save** key.

CALIBRATE SCALE				
0 Enter the known test weight.	1	2	3	
	4	5	6	
	7	8	9	
SAVE	CANCEL	0	.	DEL

3. The display will change to show “To calibrate zero, remove any weight from the scale before proceeding”. Make certain the scale is empty and then press the **Save** key.

CALIBRATE SCALE				
0 To calibrate zero, remove any weight from the scale before proceeding	1	2	3	
	4	5	6	
	7	8	9	
SAVE	CANCEL	0	.	DEL

1 = SmartCal, Cont.

4. The display will change to show “Working” for a few seconds and then change to show “Set test weight over Cell 1”.

CALIBRATE SCALE				
Working To calibrate zero, remove any weight from the scale before proceeding		1	2	3
		4	5	6
		7	8	9
SAVE	CANCEL	0	.	DEL

5. Place the calibrated test weight on the scale over Cell 1 and then press the **Save** key.

CALIBRATE SCALE				
Set test weight over Cell 1 and press Save.		1	2	3
		4	5	6
		7	8	9
SAVE	CANCEL	0	.	DEL

6. The display will change to show “Working” for a few seconds and then change to show “Set test weight over Cell 2”.

CALIBRATE SCALE				
Set test weight over Cell 2 and press Save.		1	2	3
		4	5	6
		7	8	9
SAVE	CANCEL	0	.	DEL

7. Place the calibrated test weight on the scale over Cell 2 and then press the **Save** key.

1 = SmartCal, Cont.

8. The display will change to show “Working” for a few seconds and then change to show “Set test weight over Cell 3”.

CALIBRATE SCALE				
Set test weight over Cell 3 and press Save.		1	2	3
		4	5	6
		7	8	9
SAVE	CANCEL	0	.	DEL

9. Place the calibrated test weight on the scale over Cell 3 and then press the **Save** key.
10. The display will change to show “Working” for a few seconds and then change to show “Set test weight over Cell 4”.

CALIBRATE SCALE				
Set test weight over Cell 4 and press Save.		1	2	3
		4	5	6
		7	8	9
SAVE	CANCEL	0	.	DEL

11. Place the calibrated test weight on the scale over Cell 4 and then press the **Save** key.
12. The display will change to show “Working” for a few seconds and then return to the Settings Page 5 screen.
13. Calibration is now complete.
14. Press the **Exit** key to exit Setup and return to the Weight screen.

2 = Two Calibration Points

1. With the “Number of Points” screen displayed, press the 2 key on the touchscreen and then press the **Save** key.

CALIBRATE SCALE				
2 Number of points at which the scale will be calibrated. 1 = SmartCal	1	2	3	
	4	5	6	
	7	8	9	
SAVE	CANCEL	0	.	DEL

2. The display will change to show “To calibrate zero, remove any weight from the scale before proceeding”. Make certain the scale is empty and then press the **Save** key.

CALIBRATE SCALE				
0 To calibrate zero, remove any weight from the scale before proceeding	1	2	3	
	4	5	6	
	7	8	9	
SAVE	CANCEL	0	.	DEL

3. The display will change to show “Working” for a few seconds.

CALIBRATE SCALE				
Working To calibrate zero, remove any weight from the scale before proceeding	1	2	3	
	4	5	6	
	7	8	9	
SAVE	CANCEL	0	.	DEL

4. The display will then change to show the “Known test weight” screen.

2 = Two Calibration Points, Cont.

- Place the calibrated test weight (full test load) on the scale, enter the value for the test weight and then press the **Save** key.

CALIBRATE SCALE				
1000.0 This is the known test weight that is currently on the scale.		1	2	3
		4	5	6
		7	8	9
SAVE	CANCEL	0	.	DEL

NOTE: A minimum of 50% of the scale's capacity is required, however 70% to 100% is recommended.

- The display will change to show "Working" for a few seconds and then return to the Settings Page 5 screen.

CALIBRATE SCALE				
Working This is the known test weight that is currently on the scale.		1	2	3
		4	5	6
		7	8	9
SAVE	CANCEL	0	.	DEL

- Calibration is now complete.
- Press the **Exit** key to exit Setup and return to the Weight screen.

3 = Three Calibration Points

1. With the “Number of Points” screen displayed, press the 3 key on the touchscreen and then press the **Save** key.

CALIBRATE SCALE				
3 Number of points at which the scale will be calibrated. 1 = SmartCal	1	2	3	
	4	5	6	
	7	8	9	
SAVE	CANCEL	0	.	DEL

2. The display will change to show “To calibrate zero, remove any weight from the scale before proceeding”. Make certain the scale is empty and then press the **Save** key.

CALIBRATE SCALE				
0 To calibrate zero, remove any weight from the scale before proceeding	1	2	3	
	4	5	6	
	7	8	9	
SAVE	CANCEL	0	.	DEL

3. The display will change to show “Working” and after a few seconds change to show the “Known test weight” screen.

CALIBRATE SCALE				
Working To calibrate zero, remove any weight from the scale before proceeding	1	2	3	
	4	5	6	
	7	8	9	
SAVE	CANCEL	0	.	DEL

3 = Three Calibration Points, Cont.

- With the “Known test weight” screen displayed, place the first calibrated test weight (half the test load) on the scale, enter the value for the test weight and then press the **Save** key.

CALIBRATE SCALE				
500.0 This is the known test weight that is currently on the scale.		1	2	3
		4	5	6
		7	8	9
SAVE	CANCEL	0	.	DEL

- The display will change to show “Working” for a few seconds.

CALIBRATE SCALE				
Working This is the known test weight that is currently on the scale.		1	2	3
		4	5	6
		7	8	9
SAVE	CANCEL	0	.	DEL

- With the “Known test weight” screen displayed, place the second calibrated test weight (full test load) on the scale, enter the setting for the test weight and then press the **Save** key.

CALIBRATE SCALE				
1000.0 This is the known test weight that is currently on the scale.		1	2	3
		4	5	6
		7	8	9
SAVE	CANCEL	0	.	DEL

NOTE: A minimum of 50% of the scale's capacity is required for the full test load, however 70% to 100% is recommended.

- The display will change to show “Working” for a few seconds and then return to the Settings Page 5 screen.
- Calibration is now complete.
- Press the **Exit** key to exit Setup and return to the Weight screen.

4 = Four Calibration Points

1. With the “Number of Points” screen displayed, press the 4 key on the touchscreen and then press the **Save** key.

CALIBRATE SCALE				
4 Number of points at which the scale will be calibrated. 1 = SmartCal	1	2	3	
	4	5	6	
	7	8	9	
SAVE	CANCEL	0	.	DEL

2. The display will change to show “To calibrate zero, remove any weight from the scale before proceeding”. Make certain the scale is empty and then press the **Save** key.

CALIBRATE SCALE				
0 To calibrate zero, remove any weight from the scale before proceeding	1	2	3	
	4	5	6	
	7	8	9	
SAVE	CANCEL	0	.	DEL

3. The display will change to show “Working” and after a few seconds change to show the “Known test weight” screen.

CALIBRATE SCALE				
Working To calibrate zero, remove any weight from the scale before proceeding	1	2	3	
	4	5	6	
	7	8	9	
SAVE	CANCEL	0	.	DEL

4 = Four Calibration Points, Cont.

4. With the “Known test weight” screen displayed, place the first calibrated test weight (one fourth the test load) on the scale, enter the setting for the test weight and then press the **Save** key.

CALIBRATE SCALE				
250.0 This is the known test weight that is currently on the scale.	1	2	3	
	4	5	6	
	7	8	9	
SAVE	CANCEL	0	.	DEL

5. The display will change to show “Working” and after a few seconds change to show the “Known test weight” screen.
6. With the “Known test weight” screen displayed, place the second calibrated test weight (half the test load) on the scale, enter the setting for the test weight and then press the **Save** key.

CALIBRATE SCALE				
500.0 This is the known test weight that is currently on the scale.	1	2	3	
	4	5	6	
	7	8	9	
SAVE	CANCEL	0	.	DEL

7. The display will change to show “Working” for a few seconds.

4 = Four Calibration Points, Cont.

8. With the “Known test weight” screen displayed, place the third calibrated test weight (full test load) on the scale, enter the setting for the test weight and then press the **Save** key.

CALIBRATE SCALE				
1000.0 This is the known test weight that is currently on the scale.		1	2	3
		4	5	6
		7	8	9
SAVE	CANCEL	0	.	DEL

NOTE: A minimum of 50% of the scale's capacity is required for the full test load, however 70% to 100% is recommended.

9. The display will change to show “Working” for a few seconds and then return to the Settings Page 5 screen.
10. Calibration is now complete.
11. Press the **Exit** key to exit Setup and return to the Weight screen.

LOAD CELL TRIM

Performing Load Cell Trim

1. With the scale turned on and the Weight screen displayed, press the **Menu** key.
2. The display will change to show the Settings Overview 1 screen.

SETTINGS OVERVIEW 1 >>>		
Revision 1.00.09, Display Rev. 1.0.18		
Audit Trail -- Cal=54, Cfg=12		
Range 1: 600.0 x 0.2 -- 2: 1000.0 x 0.5		
Weight Units=lb	Height Units=in	
Auto Lock=0 s	Sonar Ht=0.0 cm	
Motion=3 div.	Filter=Off	
OIML=No	ZeroTrack=10/2 d	
USB: SMA	Gravity=0.000000	
Power up zero =No		
Sonar	Exit	Setup

3. Press **Setup** on the touchscreen.
4. The display will change to show the ENTER PASSCODE screen.

ENTER PASSCODE				
Enter passcode to access settings. Press CANCEL to exit.	1	2	3	
	4	5	6	
	7	8	9	
SAVE	CANCEL	0	.	DEL

5. Using the 10-key on the touchscreen, enter 64870 and then press the **Save** key.
6. The display will change to show the Settings Page 1 screen.

SETTINGS	PAGE 1
Model: Icon	
Date: 11/6/2019	
Time: 12:24:44	
Language: English	
<<<	Exit >>>

7. Press the >>> key to advance to the Settings Page 5 screen.

Performing Load Cell Trim, Cont.

SETTINGS		PAGE 5
Calibrate Scale		
Load Cell Trim		
Power up Zero: No		
Auto Locking: 4 sec.		
<<<	Exit	>>>

8. Select **Load Cell Trim** from the Settings Page 5 screen.

LOAD CELL TRIM		
1: 2.941 mV	-	+
2: 3.334 mV	-	+
3: 3.148 mV	-	+
4: 1.747 mV	-	+
0.00	Exit	

9. Place a test weight of at least 10% of the scale capacity on each corner of the scale, one at a time, and note the reading for each corner.
10. Place a test weight on the corner with the lowest reading and adjust the appropriate cell mV reading until the reading agrees with the highest reading obtained in Step 9.

Press the **+** key to increase the mV reading

Press the **-** key to decrease the mV reading for each cell.

Performing Load Cell Trim, Cont.

11. Repeat Step 10 until all corners have the same reading.

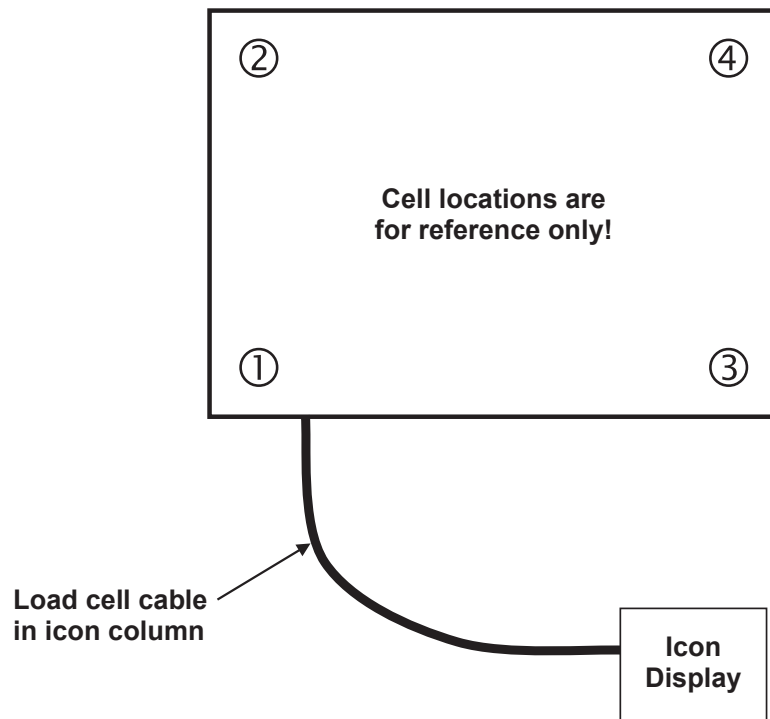

12. Press the **Exit** key to exit Load Cell Trim and return to the Settings Page 5 screen.

13. Press the **Exit** key again to exit Setup and return to the Weight screen.

WI-FI AND BLUETOOTH 5.0

The Detecto icon® Digital Clinical Scale has a Wi-Fi and Bluetooth 5.0 wireless transmitter inside the weight display that has been designed for an environment where interfacing the icon scale to a Wi-Fi network or pairing to a Bluetooth-capable device is desired.

The following sections will guide you through the setup and operation of the Wi-Fi and Bluetooth 5.0 features of the icon scale.

Wi-Fi Features

- Soft Access Point (AP) for setting credentials for Wi-Fi module
- Setup option to select static or dynamic IP address
- Built-in web server to display weight, height, and BMI
- TCP/IP connection for continuous output of weight, height, and BMI

WI-FI SETUP

Enable and Configure Wi-Fi Networking

NOTE: Default Network Settings are: Wi-Fi = Off, Bluetooth = Off, and DHCP = On.

1. With the scale turned on and the Weight screen displayed, press the **Menu** key.
2. The display will change to show the Settings Overview 1 screen.

SETTINGS OVERVIEW 1 >>>	
Revision 1.00.09, Display Rev. 1.0.18	
Audit Trail -- Cal=4, Cfg=2	
Range 1: 600.0 x 0.2 -- 2: 1000.0 x 0.5	
Weight Units=lb	Height Units=in
Auto Lock=5 s	Sonar Ht=221.5 cm
Motion=3 div.	Filter=Off
OIML=No	ZeroTrack=10/2 d
USB: SMA	Gravity=0.000000
Power up zero=No	
Sonar	Exit
Setup	

3. Press **Setup** on the touchscreen.
4. The display will change to show the ENTER PASSCODE screen.

ENTER PASSCODE				
Enter passcode to access settings. Press CANCEL to exit.	1	2	3	
	4	5	6	
	7	8	9	
SAVE	CANCEL	0	.	DEL

5. Using the 10-key on the touchscreen enter 64870, and then press the **Save** key.

Enable and Configure Wi-Fi Networking, Cont.

6. The display will change to show the Settings Page 1 screen.

SETTINGS		PAGE 1
Model: Icon		
Date: 11/6/2019		
Time: 12:24:44		
Language: English		
<<<	Exit	>>>

7. Press the >>> key to advance to the Settings Page 7 screen.

SETTINGS		PAGE 7
Bluetooth: Off		
Wi-Fi: Off		
SSID: Dynex617		
<<<	Exit	>>>

The SSID: value will not be shown if Wi-Fi: = Off.

The page advance will not be shown if Wi-Fi: = Off.

8. Touch the **Wi-Fi:** key to open a selection screen to turn the Wi-Fi wireless transmitter On. Press 1 on the entry screen, and then press the Save key.
9. Touch the **SSID:** key to open a screen that will prompt you to CLEAR SSID. Press 1 on the entry screen, and then press the **Save** key to clear the Wi-Fi credentials.

CLEAR SSID				
0		1	2	3
1= Clear wireless profile		4	5	6
		7	8	9
SAVE	CANCEL	0	.	DEL

Enable and Configure Wi-Fi Networking, Cont.

10. Press the >>> key to advance to the Settings Page 8.

SETTINGS		PAGE 8
DHCP: On		
IP: 192.168.0.133		
NM: 255.255.255.0		
GW: 192.168.0.1		
<<<	Exit	

The settings for NM: and GW: will not be shown if DHCP = On.

11. Touch the **DHCP:** key to open an entry screen to allow you to select the DHCP setting. This setting selects whether the Wi-Fi wireless transmitter will use a dynamic IP address assigned by a DHCP server or a static IP address. Consult your network administrator for the proper selection.

Using the numeric keys, enter a new setting, 0 = Static IP (Off) or 1 = DHCP (On) and then press the Save key.



NOTE: If the setting for **DHCP:** = **Off**, the settings for **NM:** (Netmask) and **GW:** (Gateway Address) will be shown on the touchscreen.

12. Touch the **NM:** key to open an entry screen to enter the Wi-Fi network Netmask for the network the scale will be connected to, and then press the Save key.

The Netmask of the scale should match the Netmask of the other computers on your network. The format for the Netmask is: ### . ### . ### . # (e.g., 255.255.255.0).

13. Touch the **GW:** key to open an entry screen to enter the Wi-Fi network Gateway Address for the network the scale will be connected to, and then press the Save key.

The format for the Gateway address is: # . # . # . # (e.g., 192.168.0.1).

14. Press the **Exit** key to exit Setup and return to the Weight screen.

15. Proceed to the Configure Wi-Fi Network Module section.

Configure Wi-Fi Network Module

Without Wi-Fi credentials, the Wi-Fi module will enter listening mode, in which it functions as a Wi-Fi access point. The SSID of the AP is of the form “REDBIRD_WIFI_XX:XX”, where XX:XX is the last 4-digits of the MAC address. Use a Wi-Fi device, such as a Smartphone, tablet, or laptop to connect to the icon scale. If the connection fails, try moving the scale to another location or cycling power to the scale.

When the connection has been made, open a web browser and go to the location **redbird.com**. The “Configure Wi-Fi” page should appear.



The screenshot shows a mobile browser interface for the 'Configure Wi-Fi' page. At the top, the time is 2:54 and the address bar shows 'redbird.com/?refresh=S'. The page features the 'Cardinal DETECTO' logo and a title 'Configure Wi-Fi'. Below the title are three input fields: 'Network Name', 'Password', and 'Device Name'. A red 'Connect' button is positioned below these fields. Further down, there is a section titled 'Available Networks' with a red 'Scan' button. A table below this section lists available networks with columns for SSID, Mac Address, and Signal Strength.

SSID	Mac Address	Signal Strength
BLUEROOM	54:75:D0:B3:0D:AF	-51
Dynex617	10:DA:43:82:56:2C	-52

Click on the **Scan** button to see a list of available Wi-Fi networks.

Configure Wi-Fi Network Module, Cont.



The screenshot shows a mobile browser interface for configuring a Wi-Fi network. At the top, the time is 2:55 and the URL is redbird.com/?refresh=S. The main heading is "Configure Wi-Fi" under the "Cardinal DETECTO" logo. There are three input fields: "Network Name" with "Dynex617", "Password" with "*****", and "Device Name" with "icon scale". A red "Connect" button is below these fields. Underneath is an "Available Networks" section with a "Scan" button. A table lists two networks: "BLUEROOM" with Mac Address "54:75:D0:B3:0D:AF" and Signal Strength "-51", and "Dynex617" with Mac Address "10:DA:43:82:56:2C" and Signal Strength "-52".

SSID	Mac Address	Signal Strength
BLUEROOM	54:75:D0:B3:0D:AF	-51
Dynex617	10:DA:43:82:56:2C	-52

Enter the Network Name (SSID), Password, and Device Name (optional) for the network you wish to connect to. Note that the Device Name can be anything. Click on the **Connect** button and the module should try to connect to that network. This may take several seconds. The module will store these network credentials and connect to this network each time the scale is turned on.

Changing the Network Credentials

1. With the scale turned on and the Weight screen displayed, press the **Menu** key.
2. The display will change to show the Settings Overview 1 screen.
3. Press **Setup** on the touchscreen.
4. The display will change to show the ENTER PASSCODE screen.
5. Using the 10-key on the touchscreen, enter 64870 and then press the **Save** key.
6. The display will change to show the Settings Page 1 screen.
7. Press the >>> key to advance to the Settings Page 7 screen.
8. Touch the **SSID:** key.
9. You will be prompted to clear the network credentials.

CLEAR SSID				
0 1= Clear wireless profile	1	2	3	
	4	5	6	
	7	8	9	
SAVE	CANCEL	0	.	DEL

10. Press 1 on the entry screen, and then press the **Save** key to clear the credentials.
11. Press the **Exit** key to exit Setup, and return to the Weight screen.
12. Repeat the steps in the Configure Wi-Fi Network Module on the previous page to set the new network credentials.

Display Wi-Fi Network Settings

1. With the scale turned on and the Weight screen displayed, press the **Menu** key.
2. The display will change to show the Settings Overview 1 screen.
3. Press the >>> key to advance to the Settings Overview 2 screen.
4. The scale's Wi-Fi network settings will be shown.
5. Press the **Exit** key to exit Settings Overview 2 and return to the Weight screen.

You should see the status of the Wi-Fi on the Settings Overview 2 screen. If a scan of Wi-Fi networks shows the "REDBIRD_WIFI_XX:XX" AP, then the module is in listening mode. Refer to the **Configure Wi-Fi Network Module** section for the procedure to set the Wi-Fi credentials.

WIFI OPERATION

Web Server

While the scale is connected to a network you can access the hosted web page. To view the web page, proceed to the IP address of the Redbird module with “/webserver.html” added to it. For example, if the IP address is “192.168.0.5”, enter **192.168.0.5/webserver.html** and a page like the following should appear.

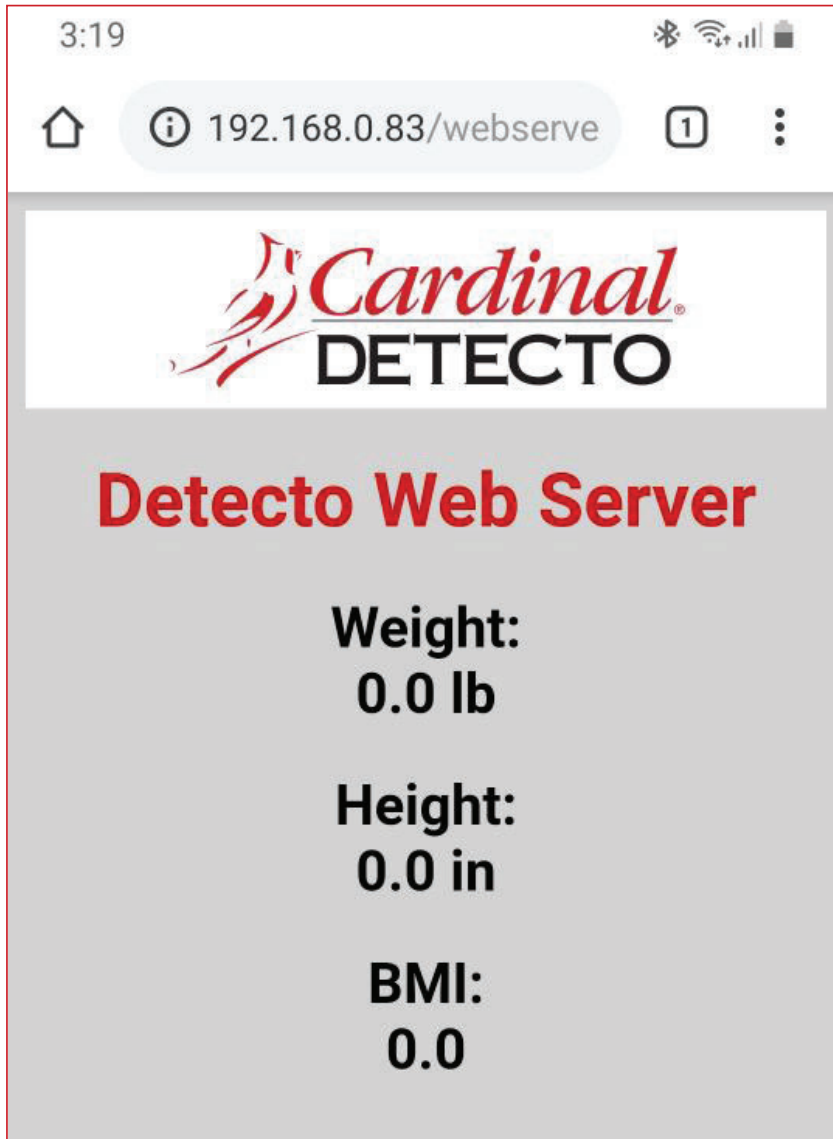

TCP/IP Connection

Continuous output is available by TCP/IP connection to the scale's IP address at port 10001.

- The scale will transmit a single set of weight data each time the SMA weight request <LF>W<CR> is received.
- Each time the SMA weight request <LF>R<CR> is received, the scale will transmit weight data continually until another SMA command is received.

SMA format for both command <LF>W<CR> and <LF>R<CR>.

<LF><s><r><n><m><f><xxxxxx.xxx><uuu><CR>

Where:

LF =	Line feed (hex 0A) = Start of response message
s =	Scale Status definition
	Z = Center of Zero <xxxxxx.xxx>= 0.000
	O = Over Capacity <xxxxxx.xxx>= +weight
	U = Under Capacity <xxxxxx.xxx>= -weight
	E = Zero Error (clears when condition clears)
	<space> = None of the above conditions NOTE: For "E" error condition <xxxxxx.xxx>= _____ (center dashes) and "Z", "O", "U" are overridden
r =	Range ("1", "2", "3", etc.) always "1" for single range
n =	Mode of Operation (Gross/Net status)
	G = Gross normal weight
	T = Tare weight (in response to "M" command)
	N = Net normal weight
	g = gross weight in high-resolution
	n = net weight in high-resolution
m =	Motion status
	M = Scale in Motion
	<space> = Scale not in Motion
f =	Future = Reserved for future or custom use
xxxxxx.xxx =	Weight with decimal point if necessary
uuu =	Units = e. g. lb, kg
CR =	Carriage Return (hex 0D) = End of response message

SMA Commands

Once a TCP/IP connection has been made to the icon scale, you can issue SMA commands to it. The icon scale will respond to the SMA commands in the format shown in the Response column of the WI-FI AND BLUETOOTH SMA COMMANDS table on pages 61 and 62 of this manual.

BLUETOOTH LOW ENERGY (BLE)

The icon® Digital Clinical Scale has a wireless transmitter inside the scale weight indicator that can be configured for Bluetooth Low Energy (BLE). When possible, BLE standard specifications are used (those that are adopted by the Bluetooth SIG). Custom services were created to request indicator and scale information whose communication protocol was developed by the Scale Manufacturers Association (SMA).

Features Available via BLE

- Device Information Service
 - Manufacturer Name
 - Model Number
 - Software Revision
- Battery Service
 - Battery Level Percentage
- Weight Scale Service
 - Weight Measurement
 - Weight Scale Feature
- Custom Services
 - Detecto SMA Service

Enable Bluetooth (BLE) Networking

NOTE: Default Network Settings are: Wi-Fi = Off, Bluetooth = Off, and DHCP = On.

1. With the scale turned on and the Weight screen displayed, press the **Menu** key.
2. The display will change to show the Settings Overview 1 screen.

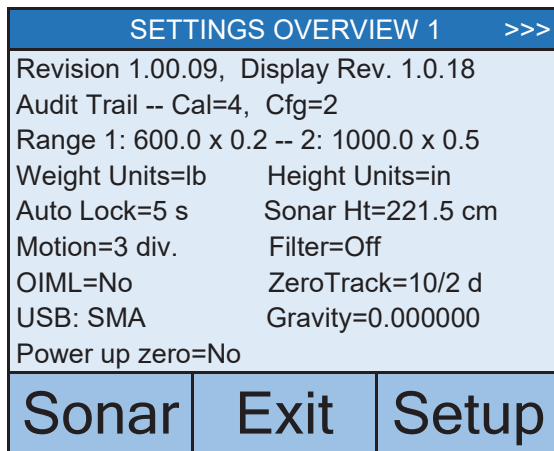

3. Press **Setup** on the touchscreen.

Enable Bluetooth (BLE) Networking, Cont.

- The display will change to show the ENTER PASSCODE screen.

ENTER PASSCODE				
Enter passcode to access settings. Press CANCEL to exit.	1	2	3	
	4	5	6	
	7	8	9	
SAVE	CANCEL	0	.	DEL

- Using the 10-key on the touchscreen enter 64870, and then press the **Save** key.
- The display will change to show the Settings Page 1 screen.

SETTINGS	PAGE 1
Model: Icon	
Date: 11/6/2019	
Time: 12:24:44	
Language: English	
<<<	Exit >>>

- Press the >>> key to advance to the Settings Page 7 screen.

SETTINGS	PAGE 7
Bluetooth: Off	
Wi-Fi: On	
SSID: Dynex617	
<<<	Exit >>>

- Touch the **Bluetooth:** key to open a selection screen to turn the Bluetooth wireless transmitter On. Press 1 on the entry screen, and then press the Save key.
- Press the **Exit** key to exit Setup and return to the Weight screen.
- The scale is now ready to pair with a Bluetooth-capable device.

Enable Bluetooth (BLE) Networking, Cont.



IMPORTANT! If an attempt is made to turn Bluetooth (BLE) off when a device is connected to the scale, the display will show the error message Error - BLE Off.

SETTINGS		PAGE 7
Error - BLE Off		
Wi-Fi: On		
SSID: Dynex617		
<<<	Exit	>>>

This message will be shown until the <<< or >>> keys are pressed to change to a different settings page, the **Exit** key is pressed to return to the Weight screen, or the error message Error - BLE Off is touched, and then CANCEL is selected on the Bluetooth selection screen.

Note that at this time, Bluetooth (BLE) is still on, only the message has been cleared.

In order to turn Bluetooth (BLE) off, the device must be disconnected from the scale or the scale must be turned Off and back On.

Bluetooth Pairing

To pair a Bluetooth-capable device with the scale, select the name of the scale from the list of available connections: Icon Scale XX:XX:XX:XX:XX:XX. Note that the X's represents the MAC address of the BLE wireless transmitter in the scale's weight indicator.

NOTE: If there are multiple icon scales in close proximity, perform the steps below to proceed to the Settings Overview 2 page to view the scale's Bluetooth Advertisement name (BLE Adv:).

BLE Adv: Icon Scale XX:XX:XX:XX:XX:XX

1. With the scale turned on and the Weight screen displayed, press the **Menu** key.
2. The display will change to show the Settings Overview 1 screen.
3. Press the >>> key to advance to the Settings Overview 2 screen.
4. The scale's Bluetooth setting and Bluetooth Advertisement name will be shown.
5. Press the **Exit** key to exit Settings Overview 2 and return to the Weight screen.

When a stable reading is achieved, and if the scale is paired with a Bluetooth-capable device, the reading will transmit when the device sends a request to receive data.

INTERFACING TO BLE

Note: 16-bit (4-digit) UUID's are adopted standards. 128-bit (32 digit) UUID's are custom services or characteristics.

Standard Services per Bluetooth SIG

Reference adopted specifications at <https://www.bluetooth.com/specifications/gatt>

Device Information Service (0x180A)

Characteristics	Number	Value(s)	Attributes
Manufacturer Name String	0x2A29	“Detecto”	READ
Model Number String	0x2A24	“Icon”	READ
Software Revision String	0x2A28	“1.0.XX” software of scale	READ

Battery Service (0x180F)

Characteristics	Number	Value(s)	Attributes
Battery Level	0x180F	0x00 – 0x64 (uint16), represents 0 – 100 percent	READ

Weight Scale Service (0x181D)

Characteristics	Number	Value(s)	Attributes
Weight Measurement	0x2A9D	<8bit Flag><uint16 weight><uint16 bmi><uint16 ht> Supported Flags: Flag bit0: 0 = SI, 1 = Imperial bit3: 0 = BMI and Height not present 1 = BMI and Height present bit4: 0 = Not below zero* 1 = Below zero* SI: Wt is KG with resolution 0.0005 Ht is meters with resolution 0.001 Imperial: Wt is lbs with resolution 0.01 Ht is inches with resolution 0.1	READ INDICATE
Weight Scale Feature	0x2A9E	NOT YET IMPLEMENTED	

- * • If the weight is below zero (0), the weight you will see is zero (0).
- If the weight is below zero (0), bit 4 of Weight Measurement will be set to 1, otherwise bit 4 is set to zero (0).

NOTE: Maximum weight value displayed is 655.35 in both pounds (lb) and kilograms (kg).

BLUETOOTH INTERFACE STANDARD PROTOCOLS

Bluetooth Characteristic – Weight_Measurement: 0x2A9D

Widely accepted BLE GATT profiles are used to transmit data to other devices/software that have implemented these profiles. Data is passed via BLE using GATT characteristic “Weight Measurement” (0x2A9D) as defined by Bluetooth SIG. Refer to the data table below about Weight Measurement Characteristics.

Weight_Measurement: 0x2A9D

NAMES	FIELD REQUIREMENTS	FORMAT	MIN. VALUE	MAX. VALUE	ADDITIONAL INFORMATION								
					BIT FIELD								
				Bit	Size	Name	Definition						
							Key	Value	Requires				
Flags	Mandatory	8 bit	N/A	N/A	0	1	Measurement Units	0	SI (Weight and Mass in Units of Kilogram (kg) and Height in Units of Meter)	C1			
								1	Imperial (Weight and Mass in Units of Pound (lb) and Height in Units of inch (in))	C2			
							1	1	Time Stamp Present	0	False		
										1	True	C3	
							2	1	User ID Present	0	False		
										1	True	C4	
							3	1	BMI and Height Present	0	False		
										1	True	C5	
4	1	Below Zero	0	Not Below Zero									
			1	Below Zero									
Weight - SI	C1	uint16	N/A	N/A	Information: Unit is in kilograms with a resolution of 0.005 and is determined when bit 0 of the Flags field is set to 0. Unit: org.bluetooth.unit.mass.kilogram Exponent: Decimal, -3 Multiplier: 5								
Weight - Imperial	C2	uint16	N/A	N/A	Information: Unit is in pounds with a resolution of 0.01 and is determined when bit 0 of the Flags field is set to 1. Unit: org.bluetooth.unit.mass.pound Exponent: Decimal, 02.								
Time Stamp	C3		N/A	N/A	Information: Smallest unit in seconds Unit: org.bluetooth.characteristic.date.time								
User ID	C4	uint8	N/A	N/A	The special value of 0xFF (255 Decimal) for User ID represents "unknown user". Information: Unit is unitless with a resolution of 1 <table border="1" style="width: 100%; border-collapse: collapse;"> <thead> <tr> <th>Key</th> <th>Value</th> </tr> </thead> <tbody> <tr> <td>255</td> <td>Unknown user</td> </tr> </tbody> </table> Unit: org.bluetooth.unit.unitless Exponent: Decimal, 0					Key	Value	255	Unknown user
Key	Value												
255	Unknown user												
BMI	C5	uint16	N/A	N/A	Information: Unit is unitless with a resolution of 0.1 Unit: org.bluetooth.unit.unitless Exponent: Decimal, -1								
Height - SI	C1 C5	uint16	N/A	N/A	Information: Unit is in meters with a resolution of 0.001 and is determined when bit 0 of the Flags field is set to 0. Unit: org.bluetooth.unit.length.meter Exponent: Decimal, -3								
Height - Imperial	C2 C5	uint16	N/A	N/A	Information: Unit is in inches with a resolution of 0.1 and is determined when bit 0 of the Flags field is set to 1. Unit: org.bluetooth.unit.length.inch Exponent: Decimal, 0-1								

BLUETOOTH INTERFACESTANDARD PROTOCOLS, CONT.

Custom Services

Detecto SMA Service (0x907a0000-8699-47dd-ab30-d7aad5f83e54)

All custom characteristics have the same base number of the Service UUID 0x907aXXXX-8699-47dd-ab30-d7aad5f83e54 where the XXXX part distinguishes the service.

Characteristics	Sub Number	Value(s)	Attributes
Rx Cmd	0001	SMA string received by scale (up to 20 chars)	WRITE
Tx Cmd	0002	SMA string sent by scale (up to 20 chars)	NOTIFY

SMA Commands

The SMA commands shown in the WI-FI AND BLUETOOTH SMA COMMANDS table on pages 61 and 62 of this manual can be sent using the Detecto SMA Service's Rx Cmd characteristic (0x907a0001-8699-47dd-ab30-d7aad5f83e54).

Responses will put out a notification on the Tx Cmd characteristic (0x907a0002-8699-47dd-ab30-d7aad5f83e54).

WI-FI AND BLUETOOTH SMA COMMANDS

The format used to send SMA commands to the icon scale is:

<LF>command<CR>

Where “command” is the ASCII letter(s), or the Hex Rep. listed in the table below. For example, <LF>Z<CR> or 0A5A0D would send the command to zero the scale. Note that the response of each command is listed under the Response column of the table.



Any invalid command sent will return a *question mark* for a response. For example, sending a <LF>XZ<CR> will return 0A 3F 0D (<LF>?<CR>).

Command	Hex Rep.	Response
Z – zero scale	0A5A0D	None. You should see scale zero itself.
D – scale diagnostics	0A440D	0A 20 20 20 20 0D = means there are no errors, EEPROM error will show an E in the second space and C will show in the third space if there is a calibration error. 20 = SPACE
W – request weight	0A570D	0A 5A 31 47 20 20 30 30 30 30 30 2E 30 30 6C 62 0D = Z1G 000000.00lb
H – request high resolution weight	0A480D	0A 5A 31 67 20 20 30 30 30 30 30 2E 30 31 6C 62 0D = Z1g 000000.01lb
A – about scale first line	0A410D	0A 53 4D 41 3A 32 2F 31 2E 31 0D = SMA:2/1.1
B – about scale scroll	0A420D	Each time sent you will get the next line of information until there is no longer any information. 1. 0A 4D 46 47 3A 44 65 74 65 63 74 6F 0D = MFG:Detecto 2. 0A 4D 46 44 3A 41 70 65 78 0D = MOD:lcon 3. 0A 52 45 56 3A 31 2E 30 2E 31 34 0D = REV:X.X.XX 5. 0A 45 4E 44 3A 0D = END: 6. If B is sent again you will get the unknown command response until the A command is sent again. 0A 3F 0D = ?
I – scale information	0A490D	0A 53 4D 41 3A 32 2F 31 2E 31 0D = SMA:2/1.1

WI-FI AND BLUETOOTH SMA COMMANDS, CONT.

Command	Hex Rep.	Response
N – scale information scroll	0A4E0D	<p>Each time sent you will get the next line of scale information until there is no longer any information.</p> <p>1. 0A 54 59 50 3A 53 0D = TYP:S</p> <p>2. 0A 43 41 50 3A 20 6C 62 3A 36 30 30 2E 30 3A 32 3A 31 0D = CAP: lb:600.0:2:1, this depends on the settings of the Icon. 600.0 – Capacity, 2 – Interval, & 1 – Decimal</p> <p>3. 0A 43 4D 44 3A 48 52 49 4E 58 0D = CMD:HRINX</p> <p>4. 0A 45 4E 44 3A 0D = END:</p> <p>5. If N is sent again you will get the unknown command response until the I command is sent again. 0A 3F 0D = ?</p>
R – Repeat Displayed Weight Continuously	0A520D	<p>0A 5A 31 47 20 20 30 30 30 30 30 2E 30 30 6C 62 0D = Z1G 000000.00lb, you should get this continuously until another SMA command is received.</p>
XB – battery level percentage	0A58420D	<p>0A 38 36 2E 32 35 0D = 86.25</p>

DISPLAY SCALE WI-FI AND BLUETOOTH SETTINGS

To View the Settings:

1. Press the  key to turn the scale on.
2. The scale will show the Detecto logo briefly and then change to the Weight screen.
3. With the Weight screen displayed, press the **Menu** key.
4. The display will change to show the Settings Overview 1 screen.

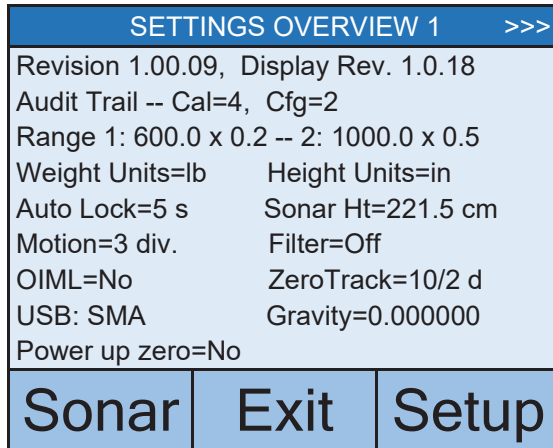

5. Press >>> on top right of touchscreen to advance to the Settings Overview 2 screen.

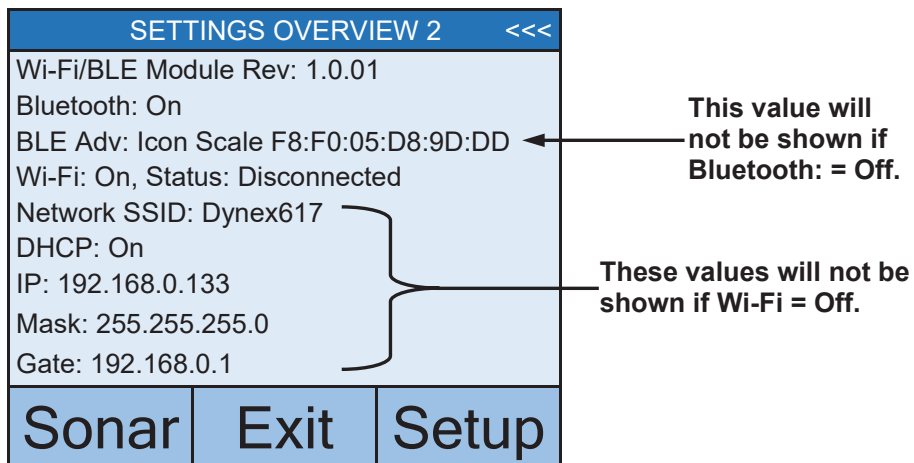

6. Press the **Exit** key to exit the Settings Overview screen and return to the Weight screen.

ERROR AND OPERATION MESSAGES

The icon scale is equipped with diagnostic software that tests various portions of the scale's circuitry and verifies proper operation. Should a problem be detected; an error or status message will be displayed. The following lists these messages and their meaning.

AUTO LOCKED

This message appears if the weight/height has been automatically locked.

BELOW ZERO

The scale weight reading is below zero.

CAL REQUIRED

The scale requires calibration, weight will show as dashes. Consult your scale service representative.

CENTER ZERO

The scale weight reading is at center of zero.

ERROR CANNOT ZERO

Scale cannot zero due to motion on scale.

LOCKED

This message appears if the weight/height has been manually locked.

MOTION

The scale is in motion based on motion range setting.

OVER CAPACITY

The scale weight exceeds scale capacity.

OVERFLOW ERROR

This message appears if there are too many characters to display on the screen.

BEFORE YOU CALL FOR SERVICE

Problem	Possible Solutions
Display does not turn on	AC Operation: <ul style="list-style-type: none">• Is AC power supply fully inserted into wall receptacle?• Check wall receptacle for proper AC power. Try another electrical appliance in same receptacle, does it work?• Check circuit breaker.• Has there been power failure? Battery operation: <ul style="list-style-type: none">• Check if batteries are installed and correctly.• If Alkaline, remove old batteries and replace with new ones.• If NI-CAD or NiMH, remove discharged batteries and replace with fully charged ones. Place discharged batteries in an external charger to recharge.
Incorrect weight is displayed	Ensure that scale platform isn't touching an adjacent object. Have proper operation procedures been followed?
Weight is not displayed	Refer to Error and Operation Messages.

CARE AND CLEANING

NOTE: The scale contains no user-serviceable parts and maintenance should be limited to an occasional cleaning and battery replacement as required.

- Do not submerge the scale in water, pour or spray water directly on it to clean. The scale is not waterproof and covering it with water will damage it and void the warranty.
- Always remove power before cleaning.
- Do not use wire brushes, abrasives, or cleaning tools such as steel pads and scrapers, which will scratch the painted surface. Instead, use soft cloths or plastic scouring pads for cleaning.
- When possible, use treated water. Hard water can leave behind deposits. Soft water is much gentler on the painted steel's surface.
- Avoid the use of acetone, thinner or other volatile solvents and abrasive type cleaners for cleaning. If required, a mild solvent such as mineral spirits can be used to remove oil, grease, tars, wax, and similar substances. Use a cloth dampened with mineral spirits and apply only to areas that are contaminated. Follow up the use of this mild solvent with detergent cleaning and rinsing.

PARTS IDENTIFICATION

Final Assembly

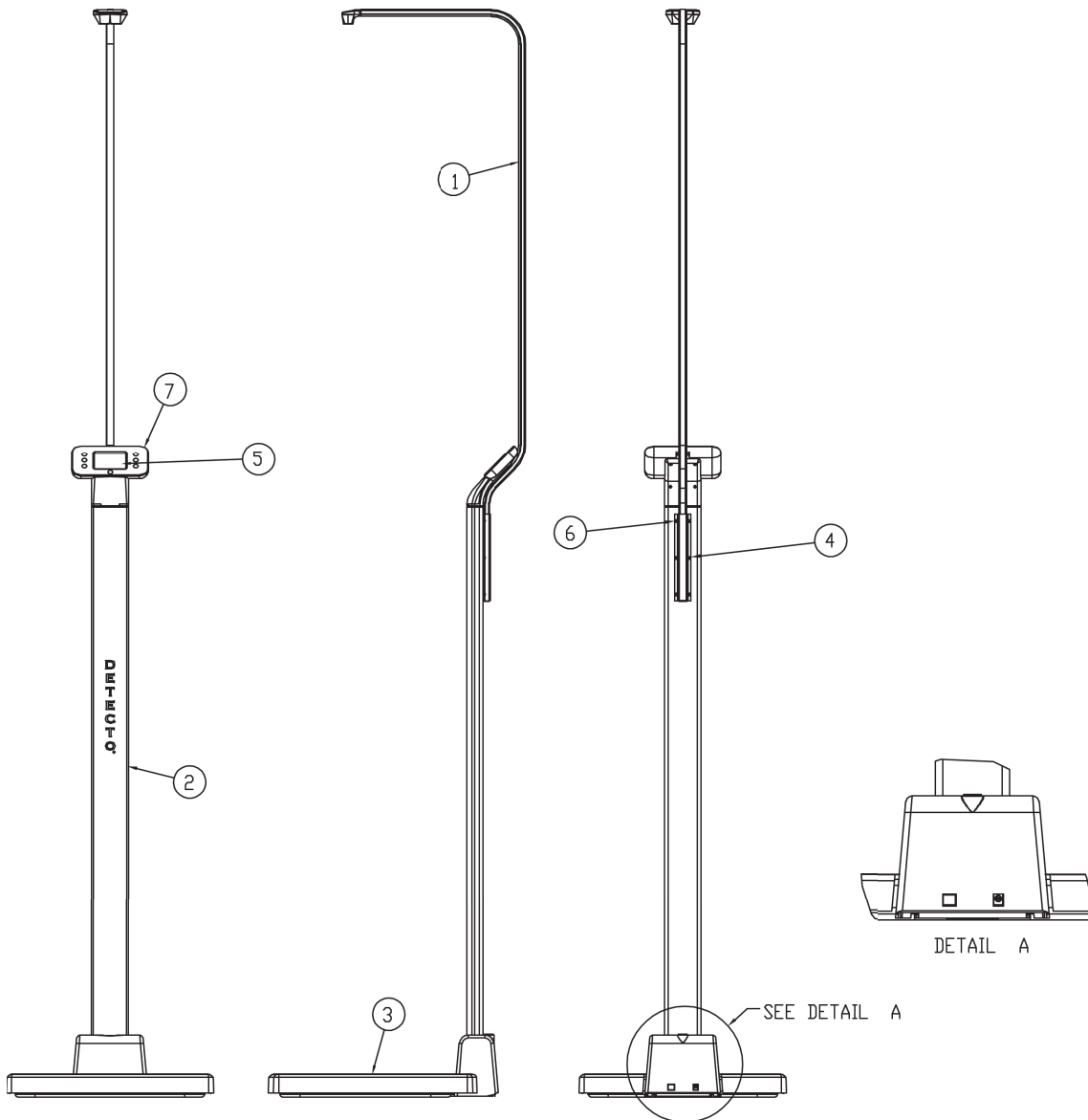

Item	Qty.	Part Number	Description
1	1	3300-0140-0A	SUB-ASSY, SONAR HR
2	1	3300-0141-0A	SUB-ASSY, ICON COLUMN
3	1	3300-0144-0A	SUB ASSY, ICON BASE
4	1	3300-0265-08	SONAR BRACKET
5	2	6021-1293	SCW FLAT-HEAD THREAD CUTTING TYPE 25, #4-24 X 1/4, PHIL. DR. Z-PLATE
6	6	6021-6017	SCW ROUND-HEAD BLUNT SS. SHEET METAL #6 X .25
7	1	3300-0151-0A	SUB-ASSY, DISPLAY, ICON
*	1	6800-1045	AC ADAPTER 100-240VAC/12VDC @ 1 AMP
*	1	6800-1047	OPTIONAL AC ADAPTER 100-240VAC/12VDC @ 1 AMP MULTI PIN INPUT

* NOT SHOWN

PARTS IDENTIFICATION

Sonar HR Sub-Assembly

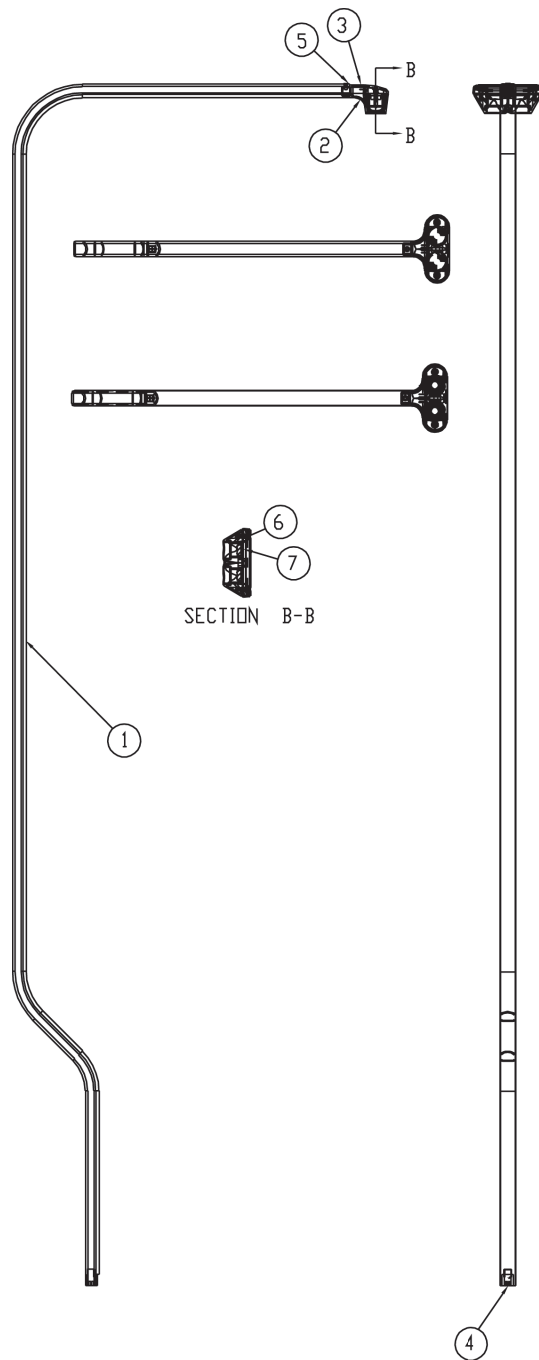

Item	Qty.	Part Number	Description
1	1	3300-0022-08	HEIGHT SENSOR TUBE
2	1	3300-0060-08	SONAR FRONT ENCLOSURE
3	1	3300-0061-08	SONAR REAR ENCLOSURE
4	1	3300-0135-0A	CABLE, ICON/APEX SONAR
5	1	6021-1293	SCW FLAT-HEAD THREAD CUTTING TYPE 25, #4-24 X 1/4, PHIL. DR. Z-PLATE
6	2	6021-2078	SCW PAN HEAD PHILLIPS #1-32X3/8" THREAD FORMING, 18-8 SS
7	1	3300-0039-2A	ULTRASONIC RANGING MODULE

PARTS IDENTIFICATION

Column Sub-Assembly

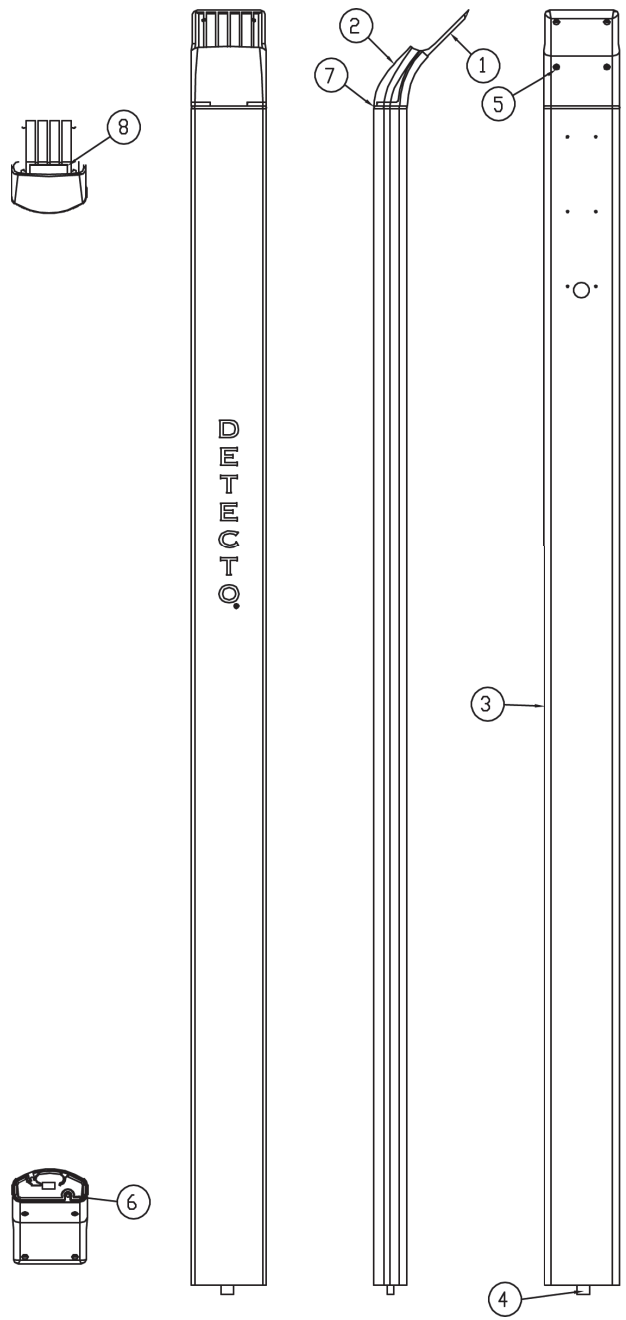

Item	Qty.	Part Number	Description
1	1	3300-0067-08	THROAT REAR
2	1	3300-0068-08	THROAT FRONT
3	1	3300-0087-08	COLUMN, DRILLED & SONAR
4	1	3300-0278-1A	CABLE, APEX COLUMN, SONAR
5	2	6021-1293	SCW FLAT-HEAD THREAD CUTTING TYPE 25, #4-24 X 1/4, PHIL. DR. Z-PLATE
6	1	6021-1509	SCW PAN-HEAD, SHEET METAL #8X.75
7	1	6650-1114	O-RING 2 ID X 2-3/16 OD X 3/32 THK
8	A/R	6710-1021	TAPE 1.88" X 60YDS DUCT ROLL

PARTS IDENTIFICATION

Display Sub-Assembly

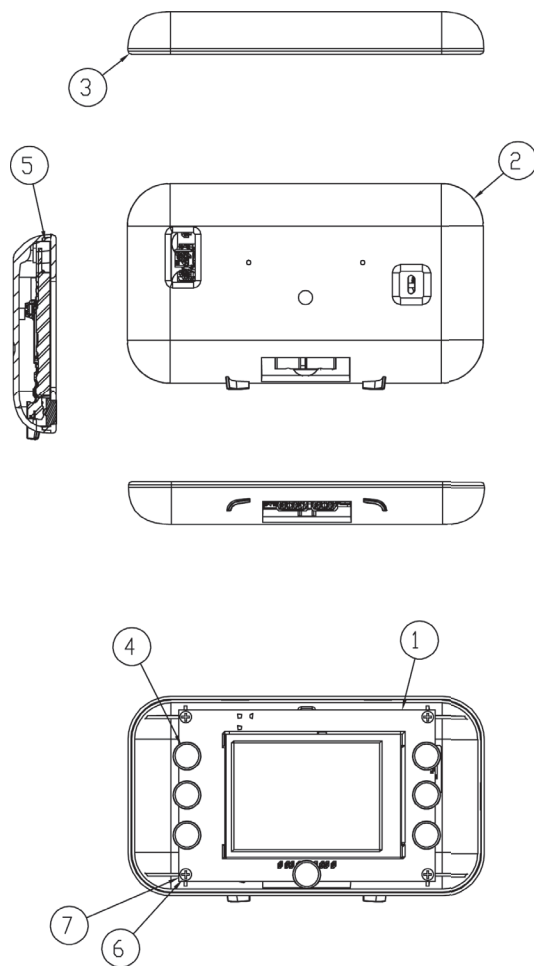

VIEW WITH FRONT DISPLAY AND UNDERLAY REMOVED

Item	Qty.	Part Number	Description
1	1	3300-0002-0A	PCB ASS'Y 855 DISPLAY W/WIFI
2	1	3300-0050-18	DISPLAY ENCLOSURE, ICON
3	1	3300-0148-0A	DISPLAY FRONT, ICON, WITH IMAGE
4	7	3300-0071-08	ICON BUTTONS
5	1	3300-0090-08	UNDERLAY FOAM, ICON
6	4	6021-1293	SCW FLAT-HEAD THREAD CUTTING TYPE 25, #4-24 X 5/16, PHIL. DR. Z-PLATE
7	4	6024-1505	WASHER FLAT 1/4 OD X .115 ID X .093 NYLON
	A/R	6560-1120	ADHESIVE LOCTITE 380 INSTANT ADHSVE 1 oz

PARTS IDENTIFICATION

Base Sub-Assembly

Item	Qty.	Part Number	Description
1	8	0065-B636-08	LOAD CELL SPACER
2	1	3300-0001-0A	PCB ASS'Y 855 ANALOG
3	1	3300-0008-0A	BASE WELDMENT
4	1	3300-0035-08	WEIGHBRIDGE
5	1	3300-0053-08	COLUMN CLAMP
6	1	3300-0058-18	SOCKET COVER, ICON
7	1	3300-0088-08	ICON COVER PLATE
8	1	3300-0130-1A	ICON ANALOG CABLE
9	1	3300-0137-0A	CABLE, ICON BATTERY
10	1	3300-0147-1A	SUB-ASSY, PLATFORM COVER, ICON
11	1	3300-0266-08	COLUMN CONNECTOR BRACKET, ICON
12	4	6013-0049	NUT 1/4-20 HEX JAM
13	8	6013-0295	NUT #10-32 HEX Z/P
14	4	6013-2008	NUT 1/4-20 CAGE Z/P
15	2	6021-0654	SCW PAN-HEAD, MACHINE-SCW 06-32X.250
16	4	6021-1033	SCW ROUND-HEAD MACHINE-SCW 10-32X.250
17	4	6021-1417	SCW SOCKET-HD. CAP-SCREW, 25-20X2.0
18	4	6021-1473	SCW PAN-HEAD, MACHINE-SCW .25-20X.3125
19	8	6021-1638	SCW HEX/WASHER, SELF-TAP 10-32X.625, Z/P
20	8	6024-0033	WASHER LOCK HELICAL SP #10 REG Z-PL
21	4	6031-0223	VIBRATION MOUNT, 1/4" – 20 MALE-FEMALE, 1" OD, 1/2" BASE HEIGHT
22	A/R	6560-1061	ADHESIVE LOCTITE 262-21 THREADBLOCKER, HS
23	A/R	6560-1125	ADHESIVE LOCTITE 290 THRD LCKR, WICKING
24	1	6690-0001	LEVEL, "BULLSEYE" TYPE
25	A/R	6710-1021	TAPE 1.88" X 60YDS DUCT ROLL
26	1	593GR986	SERIAL TAG ASSY
27	4	FP-250	LOAD CELL, FLAT PLATE, 250 LBS

PARTS IDENTIFICATION

Base Sub-Assembly

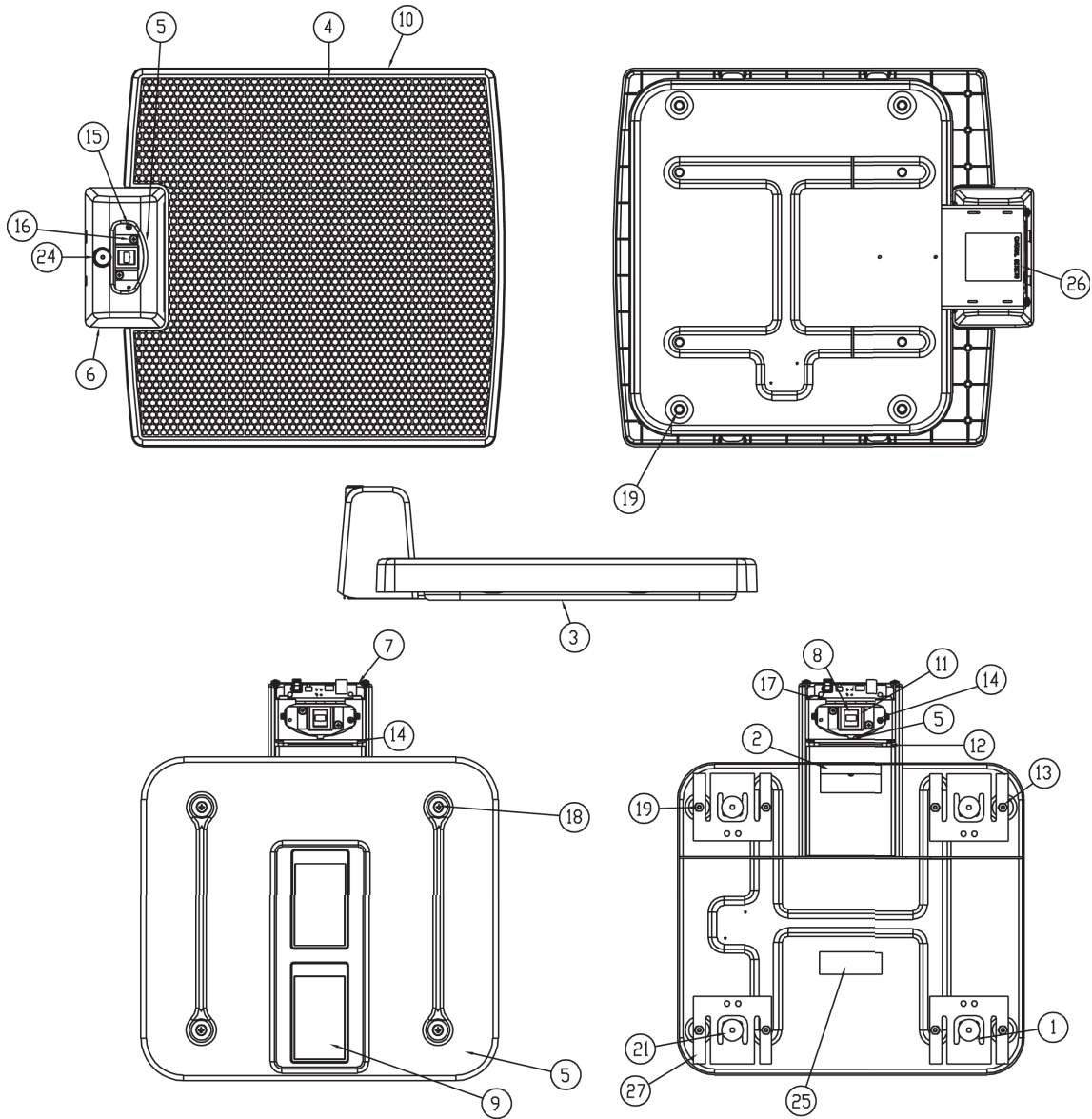

STATEMENT OF LIMITED WARRANTY

Detecto Scale warrants its equipment to be free from defects in material and workmanship as follows: Detecto warrants to the original purchaser only that it will repair or replace any part of equipment which is defective in material or workmanship for a period of two **(2) years from date of shipment**. Detecto shall be the sole judge of what constitutes a defect.

During the **first ninety (90) days** Detecto may choose to replace the product at no charge to the buyer upon inspection of the returned item.

After the first ninety (90) days, upon inspection of the returned item, Detecto will repair or replace it with a remanufactured product. The customer is responsible for paying for the freight both ways.

This warranty does not apply to peripheral equipment not manufactured by Detecto; this equipment will be covered by certain manufacturer's warranty only.

This warranty does not include replacement of expendable or consumable parts. This does not apply to any item which has deteriorated or damaged due to wear, accident, misuse, abuse, improper line voltage, overloading, theft, lightning, fire, water or acts of God, or due to extended storage or exposure while in purchaser's possession. This warranty does not apply to maintenance service. Purchased parts will have a ninety (90) day repair or replacement warranty only.

Detecto may require the suspect product to be returned to the factory; item(s) must be properly packed and shipping charges prepaid. A return authorization number must be obtained for all returns and marked on the outside of all returned packages. Detecto accepts no responsibility for loss or damage in transit.

STATEMENT OF LIMITED WARRANTY

Conditions Which Void Limited Warranty

This warranty shall not apply to equipment which:

- A.) Has been tampered with, defaced, mishandled or has had repairs and modifications not authorized by Detecto.
- B.) Has had serial number altered, defaced, or removed.
- C.) Has not been grounded according to Detecto's recommended procedure.

Freight Carrier Damage

Claims for equipment damaged in transit must be referred to the freight carrier in accordance with freight carrier regulations.

This warranty sets forth the extent of our liability for breach of any warranty or deficiency in connection with the sale or use of the product. Detecto will not be liable for consequential damages of any nature, including but not limited to, loss of profit, delays or expenses, whether based on tort or contract. Detecto reserves the right to incorporate improvements in material and design without notice and is not obligated to incorporate improvements in equipment previously manufactured.

The foregoing is in lieu of all other warranties, express or implied including any warranty that extends beyond the description of the product including any warranty of merchantability or fitness for a particular purpose. This warranty covers only those Detecto products installed in the forty-eight (48) contiguous continental United States.



Ph. (800) 641-2008
E-mail: detecto@cardet.com
203 E. Daugherty
Webb City, MO 64870

08/27/2014
Printed in USA
D268-WARRANTY-DET-A



Printed in USA

3300-0192-0M Rev H 03/20



Cardinal Scale Manufacturing Co.
102 E. Daugherty, Webb City, MO 64870 USA
Ph: 417-673-4631 or 1-800-641-2008
Fax: 417-673-2153

Technical Support: 1-866-254-8261
E-mail: tech@cardet.com