

US-6011 SERIES INDICATOR

USER'S MANUAL

(US-6011SS-4-20MA & US-6011SS-R)



Contents

DEFINITION OF TERMS -----	3
SAFETY PRECAUTIONS & MAINTENANCE-----	4
PREPARATION & SET UP -----	5
POWER SUPPLY-----	7
DISPLAY AND KEY DESCRIPTION -----	8
OPERATING INSTRUCTIONS-----	9
CALIBRATION-----	12
INDICATOR PARAMETER SETTINGS -----	14
CONNECTORS -----	21
RS232 SERIAL OUTPUT FORMAT-----	23
US-6011SS-4-20 mA Analog Output -----	27
RELAY OUTPUT -----	29
TROUBLESHOOTING-----	30
FAQs-----	31

DEFINITION OF TERMS

In the context of this guide, the underlisted words are presumed to mean:

Division: The amount of increments a scale offers. How accurate the scale can be

Capacity: the maximum amount the scale can contain

Initial Zero Range: The percentage of weight allowed on the scale when indicator is powered on that will automatically zero.

example: If initial zero range is set to 10% of the max. capacity and your max. capacity is 100lbs, you can place up to 10lbs of weight on the scale and when the indicator is powered on, it will automatically zero out the weight.

Manual Zero Range: The percentage of weight allowed on the scale where the indicator will let you manually zero (anything above this percent will be tared)

Zero Tracking Range: A subset to the manual zero range; if the weight on the scale is not stable, the zero tracking range still allows you to zero within a set division of the scale

Zero Tracking Time: A subset to the zero tracking range, it is the time allowed for the scale to fall within the zero tracking range tolerance and still qualify to be zero'd

Overload Range: Weight allowance that is out of the set calibrated range. Adds a tolerance to the calibrated max. capacity without having to recalibrate.

example: If your scale has a max. capacity of 1000lbs with a division of 1 and you set the overload range to 60, you can add 1060lbs of weight to the scale without it displaying an error code

Negative Display: How far you can go in the negative direction before displaying an error code

Standstill Time: How fast the scale will stabilize

Standstill Range: How much the scale can fluctuate before being determined stable

Digital Filter: For filtering moving weight, such as animals, It changes how sensitive the scale is to variations in movement.

Noise Filter: A filter for how susceptible the scale is to general variations

Baud Rate: The rate at which information is transferred in a communication channel.

example: In the serial port context, "9600 baud" means that the serial port is capable of transferring a maximum of 9600 bits per second.

SAFETY PRECAUTIONS & MAINTENANCE

WARNING: The use of procedures not specified in this user manual may result in electrical hazards.

Follow these instructions when using the weighing indicator:

1. The weighing indicator should be on a stable surface.
2. Do not touch the internal components with your hands
3. Disconnect any form of power supply when making electrical connections because the weighing indicator is sensitive to static electricity.
4. Avoid climbing on the unit
5. If any of the components are cracked, do not use the product under any circumstance.
6. The use of the weighed indicator is restricted to weight measurement
7. Unplug the charger once the battery is fully charged to prevent damaging the battery.
8. Limit the weight on the indicator to the prescribed Maximum capacity to prevent damaging the inner load cell.
9. Stay with in the unit's rated load limit
10. Do not leap on the scale
11. Only professional staff should conduct the calibration inspection and maintenance of the weighing indicator.
12. If the sample to be weighed consists of material containing static electric charge, discharge the samples' static electricity before weighing it. This is important because the static electricity may influence the weighing process. Alternatively, clean the pan (both sides) and the case top with an anti-static agent.

This manual emphasizes the need to take anti-static precautions

Before opening the protective container that contains ESDS devices, ensure any accumulated charge on the human operator's body has been dissipated to avoid any hazardous situation. Placing one's hands on a grounded surface or, preferably, wearing a grounded Anti-static Wrist Strap and an Anti-static Mat can be used to dissipate the accumulated charge.

PREPARATION & SET UP

This user manual highlights the basic requirements to enable the smooth operation of the weighed indicator.

1. Plug the scale into a wall socket to avoid interference with other electrics.
2. Ensure there is no load when the indicator is turned on.
3. The initial installation (or movement from a location) may require that you
4. calibrate the scale before using it to weigh any load.

FEATURES

- Stainless Steel or Mild Steel Enclosure
- 1" Digit in LED or LCD display option
- Weighing Units LED: lb, kg
- Weighing Units: LCD lb, kg, oz, lb:oz, g
- Gross Weighing
- Multiple Tare Functions
- Pre-Set Tare Option
- Zero Button
- Multiple Hold Functions
- Counting Pieces Function
- Accumulation / Batch weighing
- Checking Weighing: Overload/ Underload with alarm
- Power saving mode
- Automatic date and time update
- Modify gravity based on location
- 100% manual zero range setting
- Automatic error warning alarm
- Splash proof keyboard and display
- RS-232 Port for optional Scoreboard
- RS-232 Port for connecting to Printer or PC
- Displays up to 50,000 graduations
- Includes Bracket & Mounting Hardware
- 110V Power Adapter Included
- Easy to Calibrate Indicator (5 Steps)
- Full Duplex RS-232 Serial Port
- Powers up to (6) 350 ohm load cells
- 2-year Manufacturer warranty
- NTEP approved for 5,000 divisions

Indicator Model Options

The US-6011 indicator comprises of four models the US-6011MS-LCD, US-6011MS- LED, US-6011SS-LCD and US-6011SS-LED. The mild steel (MS) and stainless steel (SS) models feature a red digit display type for LED, while the display type for LCD is black digits.

The purchase includes, US-6011 digital indicator, rechargeable battery, stainless steel mounting bracket, 2 adjustable knobs for bracket, spare connectors, plastic splash guard, 15' stainless steel braided cable, power adapter, as well as this user manual.

Technical Considerations

- Accuracy class: 5000 e
- Resolution – Display: 30,000 ; ADC: 2,000,000
- Zero stability error: $TK_0 < 0.1 \text{Mv//K}$
- Span stability error: $TK_{\text{spn}} < \pm 6 \text{ppm//K}$
- Sensitivity (internal): 0.3 Mv / d
- Input voltage: -30 to +30Mv DC
- Excitation circuit: 5 VDC, 4 wire connection, 6 load cell of 350ohm max
- AC power: AC 100-250V (use only the included 9V adapter supplied)
- Operation temperature: $-10 \text{ }^\circ\text{C} \sim +40 \text{ }^\circ\text{C}$
- Operation humidity: $\leq 90\% \text{RH}$
- Storage temperature: $-40 \text{ }^\circ\text{C} \sim +70 \text{ }^\circ\text{C}$ (32-104°F)

SPECIFICATIONS

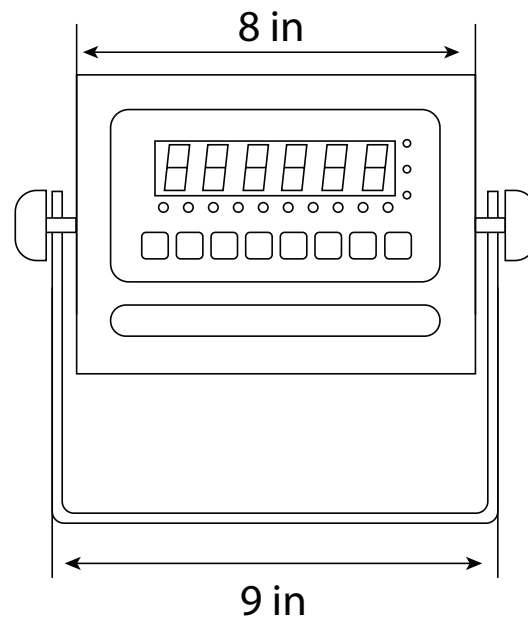
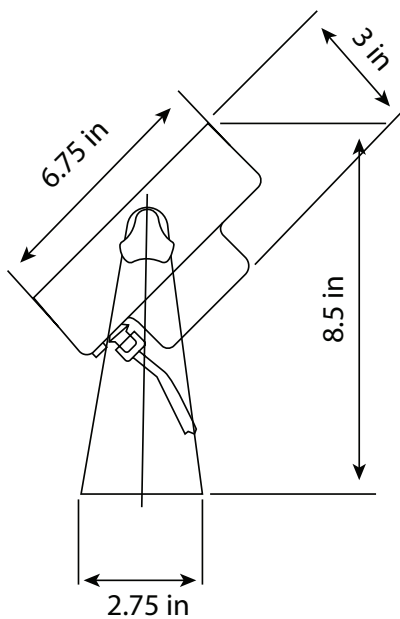
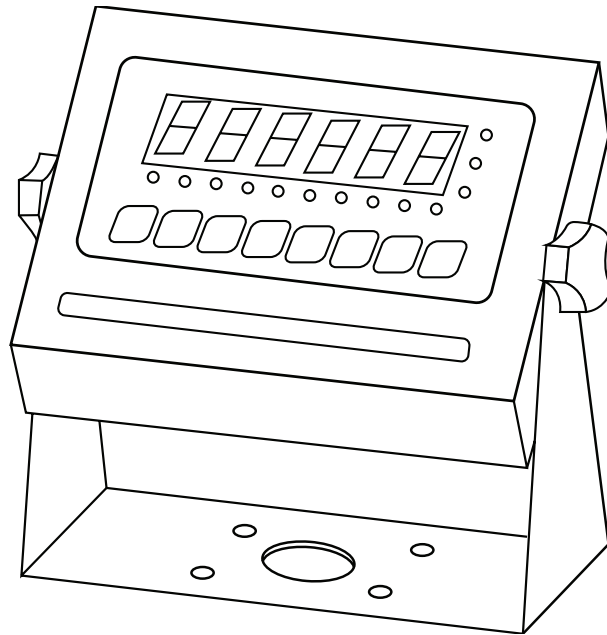

POWER SUPPLY

The indicator has a 110V power adapter with an option to use the rechargeable battery at one's convenience.

When using the power adapter:

It is recommended that the power adapter should be plugged into a wall socket to avoid interference with other electrics. There is a DC pin at the bottom of the indicator where you can plug the adapter to while using the indicator.

When using the rechargeable battery:



If it is the first time of using the rechargeable battery, ensure that the internal battery is fully charged. It is important that you discharge the battery completely every month to keep the battery in its best condition. When you want to discharge the battery, you are required to leave the indicator on until the indicator powers goes off. Remove the battery when it is not being used for a long period of time to prevent leakage.

We advise that you use the 110V AC adapter provided upon purchase of the indicator to prevent any form of damage to your indicator.

Battery signs for LED series:

The battery indicator flashes red when the battery is low; and stays lit during the charging process. You can unplug the charger when the light turns green because the green light indicates a full charge.

Battery signs for LCD series

-  means that the battery is fully charged
-  means that the battery needs to be charged
-  means that the battery is charging

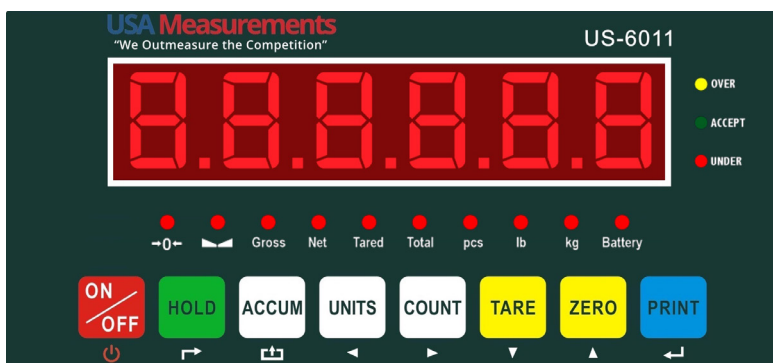



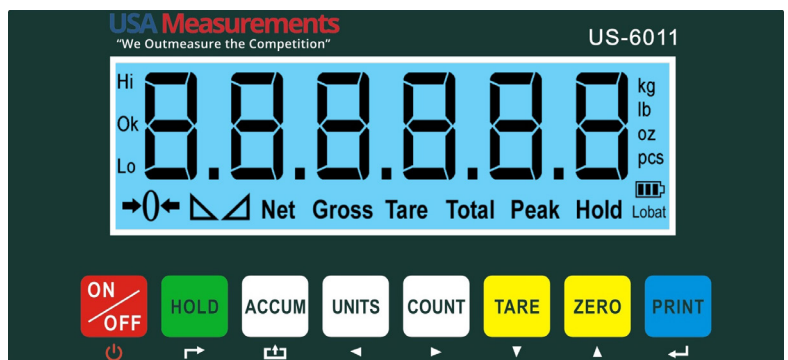

US-6011MS (LED)

US-6011MS (LCD)



DISPLAY AND KEY DESCRIPTION

DISPLAY FUNCTION	DESCRIPTION
ON/OFF	Press for 2 seconds, to on or off the indicator
HOLD	
TOTAL	<ol style="list-style-type: none"> 1. accumulates weights 2. performs the accumulation function and accumulation result, alongside the "Print" function.
UNITS	Indicates changes in weighing units
COUNT	To count products based on a sample weight, use the scale.
TARE	<ol style="list-style-type: none"> 1. Resets the scale to zero when something is on it (ex. Tare out the weight of pallet to weigh only the product on it). 2. Removes the tare to see the gross weight (pallet + product)
ZERO	Indicates that the scale is zero
PRINT	Means data should be printed ; confirms inputs
	Shows that the scale is at zero
	Shows that the scale is stable
Gross	Shows when in Gross weight mode, including Tare; default mode
Net	Shows when in Net weight mode, without tared weight
Total	Shows when in accumulation mode
Hold	Shows when in Hold mode
lb	Indicates weight in pounds
Kg	Indicates weight in kilograms
Battery	Blinking red- low battery, Solid red – charging, Green- fully charged.
Over	Blinks when weight is higher than the set alarm parameter
Accept	Blinks when weight is within the set alarm parameter
Under	Blinks when weight is lower than set parameter
	Power
	Back
	Save and Exit
	Arrow keys
	Return/Enter/print

OPERATING INSTRUCTIONS

Power On

- Press the **"ON/OFF"** button for 20 seconds to power the scale ON.

The scale will automatically flash the voltage and auto-check. It performs a sequential countdown from 0 to 9 before entering the weighing mode. The Scale also tares out anything on it before powering on.

Zero function

This function is applied when the scale is empty. It cannot be used if material build up places the scale at gross zero.

- To reset your scale display to 0, press the **ZERO** function.

You are allowed to zero out any number within your set selection, depending on the setting of your manual zero range parameter. After that, you will receive an error and will have to tare out the weight.

Unit Selection

- Use the **UNITS** button to toggle measurement units between kilogram (kg), grams (g), pounds (lb), ounces (oz).

Tare Function

The Tare function enables you see the current change in weight, as against the entire weight on the scale. To view the changes,

- Add the pallet to the scale
- Press the TARE button when the indicator is in gross mode. When you do that, the current weight on the scale will be tared and the scale will enter the net mode.
- Add your product to the scale to weigh without the pallet's weight.
- If you want to exit net mode, press the TARE button again to enter the gross mode.

When you exit net mode, the total weight of the pallet and product will be shown on the scale. If however, you remove the pallet, the scale will show the minus weight of the pallet.

For a pre-set tare weight,

- Press and hold the TARE key for 2 seconds
- Input the tare weight using the arrow keys
- Press print key to confirm

Counting Function

If you want to count a high volume of identical parts, then the counting function is the option. You can either set a sample on the scale, and add to it or take away from the sample to count the number of objects on the scale. When you enter weighing mode,

- Place a sample on the scale.
- Press the **COUNT** button to enter the counting mode.
- In counting mode, PCS will show on the scale.
- The sample number will be displayed on the scale, which can be changed using the arrow buttons (up and down arrow buttons).
- PCS precedes the sample number on display.
- Press the **PRINT** button to confirm your sample number

- After pressing the **PRINT** button, you can load the product on the scale.

The indicator will show the product quantity on display. Press the **COUNT** button to exist the counting mode. If you want to determine the quantity of a different product hold the **PRINT** and **COUNT** key together and the sample pieces will reset back to zero.

Accumulation

When adding multiple weights, use the accumulation function to get the weight total.

- Load the first weight in the weighing mode.
- When it is stable, press the **ACCUM** button to enter the accumulation mode.
- The “**total**” indicator/light will be displayed on the scale.
- When the first weight is saved, the screen will show “**n001**”
- Remove the first weight and press the **ZERO** key to stabilize the scale
- Add the second weight to the scale
- When it is stable, press the **ACCUM** button to add the weight to the accumulated total
- “**n002**” to indicate the second weight has been saved
- Repeat previous steps until all desired weights have been added to the total
- When you are done and want to display the accumulated total, press the **ACCUM** and **PRINT** key together. The accumulated number “**n002**” (the number of weights you are adding together) will flash on the display followed by the total
- The total will display by flashing between 2 sets of numbers
- If you want to print the accumulated total, hold the **PRINT** key for one second while the last 4 digits of the total are shown
- To exit accumulation mode, wait for the last 4 digits to the right of the screen to appear, and then press and hold the **ACCUM** key for one second
- “**CLr n**” will be displayed, asking you if you want to keep the data
- If **NO**, you do not want to clear the accumulated total, then keep “**CLr n**”.
- If **YES**, you do want to clear the total, then use the arrow button to change to “**CLr y**”
- Press the **PRINT** key to select exit accumulation mode

Hold

There are 4 different hold functions you can choose from in the parameter

1. Peak Hold: The peak hold function grabs the highest weight (in respect of materials testing, that is, tension and pulling force)

- Press the **HOLD** button
- Add weight to the scale

The indicator will show the highest weight it recorded and hold it on the screen until a higher weight is placed on the scale

2. Manual Hold: It is the current weight and holds it so it will not change/fluctuate

- While weighing, press **HOLD** and the indicator will hold the current weight on the screen until **HOLD** is pressed again

3. Auto Hold: If the weight on the scale is above 20d (20 x division) and is stable, the indicator will hold that weight on the screen for 3 seconds then go back to general weighing

- You do not need to press the **HOLD** button because holding is done automatically when the scale is stable.

4. Average Hold: It is used for weighing animals, the indicator will display the average weight sampled from 3 seconds

- Add livestock to scale and press **HOLD**
- Indicator screen will show "**LOC**" for 3 seconds, then display the average weight from those 3 seconds
- Press HOLD again to exit holding mode

Print

- If the indicator is connected to a printer and the weight on the scale is stable press the **PRINT** key to print the current weight
- In accumulation mode hold the **PRINT** key for one second when the last 4 digits of the total weight are shown to print the total weight

Note: In Tare mode the printer can not print if negative weight is shown

CALIBRATION

1. Turn on the scale by holding **ON/OFF** for 2 seconds.
2. Press **HOLD** and **PRINT** together to access the setup menu.
3. If done correctly, the display should now show **C01**.
4. Press **PRINT** to access the **C1** channel. The display should show **[C1 #]**.
5. Press **ZERO** to choose which unit you want to calibrate in (**1 = kg, 2 = lb**).
6. Press **PRINT** to set the value. The display will now show **C02**.
7. Press **PRINT** to access the **C2** channel. The display should show **[C2 #]**.
8. Press **ZERO** to change the setting to the decimal places desired (The **C2** channel is used to adjust the decimal point on the scale. A value of 1 means there is one digit behind the decimal point.)
9. Press **PRINT** to set the value. The display will now show **C03**.
10. Press **PRINT** to access the **C3** channel. The display should show **[C3 #]**.
11. Press **ZERO** to cycle through the values until the desired graduation appears. (The **C3** channel adjusts the divisions on the scale. A value of 1 selected and **C2** set to 1, the scale will read in 0.1 lb. increments.)
12. Press **PRINT** to set the value. The display will now show **C04**.
13. Press **PRINT** to access the **C4** channel. The display will show **[#####]**.
14. Enter in the maximum capacity you want to use for this scale by using **UNIT** and **COUNT** to move the cursor left and right, and **TARE** and **ZERO** to move the values down and up. (The **C4** channel is used to enter in the max capacity of the scale; Make sure this doesn't exceed the max capacity of the scale; Max capacity divided by the increment set in **C02** and **C03** above cannot exceed 5000.)
15. Press **PRINT** to set the value. The display should show **[C5 0]**
16. Press **PRINT** to access the **C5** channel. The display should show **[C5 0]**.
17. The **C5** channel calibrates zero on the scale. Make sure the scale is empty.
18. Press **ZERO** to change the value to 1.
19. Press **PRINT**. The display will count down from 10-1 while the scale is calibrating zero. When the display shows 0 the zero calibration is complete.

US-6011 offers 2 calibration methods, Single Point which uses one weight to calibrate or Linear Calibration, which uses multiple (2-7) weights for a more accurate calibration.

To Calibrate using only 1 calibration weight (Single Point Calibration)

1. Press **PRINT** to continue. The display will now show **C06**.
2. Press **PRINT** to access the **C06** channel. The display will show **[C6 0]**.
3. The **C6** channel is used to calibrate the scale with a known weight.
4. Press **ZERO** to set the value of **C6** to **[C6 1]**. Press **PRINT**. The display will flash **SPAN**, and then show **[#####]**. Enter the calibration weight value you will use (at least 10% of max capacity you set in **C04** by using **UNIT** and **COUNT** to move the cursor left and right, and **TARE** and **ZERO** move the values down and up.
5. Place the calibration weight you have on the empty scale and press **PRINT**
6. The scale will count down from 10 to 0. Once 0 has been reached, the display will show **CALEnd**.
7. Press **PRINT** to continue. The display will now show **C07**.
8. Press **ACCUM** to save and exit the setup menu
9. The scale has now been calibrated. The display will show the value of the calibration weight on the scale,
10. If the scale does not show the value of the calibration weight, check that the feet on the platform are not screwed in too tightly, and verify that the platform is level.
11. Unload the scale; the display should read **000000**.
12. If the scale does not display **000000**, check that the feet on the platform are not screwed in too tightly, and verify that the platform is level.

To Calibrate using only multiple calibration weights (Linear Calibration)

1. Press **PRINT** to continue. The display will now show **C06**.
2. Press **PRINT** to access the **C06** channel. The display will show **[C6 0]**.
3. The **C6** channel is used to calibrate the scale with a known weight. Press **ZERO** to set the value of **C6** to **[C6 2]**. Press **PRINT**. The display will flash **SPAN**, and then show **[LnE 2]**.
4. Press **ZERO** to enter the number of weights you want to use (**2-7**); the more you use, the more accurate the calibration will be. (an example of 2 will be used)
5. Press **PRINT** to set your value. The screen will flash **[dbno01]** then **[000100]**
6. Enter the lowest calibration weight value you will use (at least 10% of max capacity you set in **C04**) by using **UNIT** and **COUNT** to move the cursor left and right, and **TARE** and **ZERO** move the values down and up.
7. Place the calibration weight you have on the empty scale and press **PRINT**.
8. The scale will count down from 10 to 0. Once 0 has been reached, the display will show the screen will flash **[dbno02]** then **[000200]**
9. Enter the next calibration weight value you will use by using **UNIT** and **COUNT** to move the cursor left and right, and **TARE** and **ZERO** move the values down and up.
10. Place the calibration weight you have on the empty scale and press **PRINT**.
11. The scale will count down from 10 to 0. Once 0 has been reached, the display will show the screen will show **CALEnd**.

Then follow steps 1-12 on the single point calibration instructions

INDICATOR PARAMETER SETTINGS

The parameter settings menu has a calibration section (C01 to C07 explained above) and a parameter settings section (C08 and up). To access the calibration section the seal switch (located at one corner of the PCB) must be OFF. This will allow access to all C01 and up settings. If the seal switch is ON, then only C08 and up can be accessed by the user. If you break the official seal by opening the back of the indicator to access the seal switch, you may need to have the indicator recertified. Be sure to adjust the seal switch back to the original setting after calibration/configuration has been performed.

To enter calibration/parameter settings, follow the procedure below:

1. Make sure the unit is set to either kg or lb
2. Press and hold the **HOLD** and PRINT key at the same time for 2 seconds
3. Navigate through the settings (**C01 to C45**) as shown in the table 4 below by using the arrow buttons and return buttons as labeled under each indicator key
4. Press the **PRINT** button to enter/edit the parameter setting Press the **ACCUM** key to save and exit settings at any time.

Table 1. Indicator Parameter Settings

Function	Parameter	Settings/Options
Weighing Unit	C01	0 = kg 1 = lb 2 = gram 3 = oz Note: for calibration only kg or lb are allowed
Decimal Setting	C02	0 = no decimal 1 = 0.0 2 = 0.00 3 = 0.000 4 = 0.0000
Graduation Setting (readability of the least significant digit)	C03	options: 1/2/4/10/20/50 Example with no decimal places (ie. C02=0) 1= 1 lb 2= 2 lb 5 = 5 lb 10 = 10 lb 20 = 20 lb 50 = 50 lb
Maximum Capacity	C04	set max capacity ex. 100kg = 0100.00
Zero Calibration	C05	0 = zero calibration not needed 1 = set the zero calibration (Please ensure scale is empty and the stable light is on)

Calibration	C06	0 = calibration not needed 1 = Ready to calibrate with one calibration weight 2= Ready to calibrate using multiple calibration weights (Linear) 3 = Sensitivity Output
Restore Default Settings	C07	0 = do not restore 1 = restore to default settings
Warning Tone	C08	0 = turn off warning tone 1 = turn on warning tone
Automatic Power Off	C09	0 = turn off auto power off 10 = power off automatically if no change within 10 minutes 30 = power off automatically if no change within 30 minutes 60 = power off automatically if no change within 60 minutes
Power Saving Mode	C10	LED Version OP900A: 0 = turn off power saving setting 3 = turn off display if no change within 3 minutes 5 = turn off display if no change within 5 minutes LCD Version OP900B: 0 = turn off the backlight 1 = backlight only when the weight changes or keyboard is pressed 2 = constant backlight
Hold Function	C11	0 = turn off hold function 1 = Peak hold - Grabs the highest weight 2 = Manual hold - Grabs the current weight 3 = Auto hold - Automatically holds data when stable 4 = Average hold - for animal weighing, averages the weight from a sample of 3 seconds 5 = Auto Average hold - Average hold without the need to press the hold key
Unit Conversion	C12	see table 2
Upper Limit Alarm	C13	Set upper limit within the max. capacity
Lower Limit Alarm	C14	Set lower limit within the max. capacity
Inner Code Display	C15	check the inner code (raw data)
Set Date	C16	Set date from left to right: year/month/day
Set Time	C17	Set the time from left to right: hour/minute/second

Communication Setting	C18	<p>Set the serial interface data output method:</p> <p>0 = Turn off serial interface data output</p> <p>1 = Continuous sending mode, for remote display</p> <p>2 = Print to paper thermal ticket printer</p> <p>3 = Command request mode, for computer.</p> <p>4 = PC continuous sending mode, for computer</p> <p>5 = PC/remote display, continuous sending mode</p> <p>6 = Print to adhesive label thermal printer</p> <p>7 = Print to Zebra/large adhesive label thermal printer</p> <p>8 = Reserved</p>
Baud Rate	C19	<p>0 = 1200 (for OP-910 remote display)</p> <p>1 = 2400</p> <p>2 = 4800</p> <p>3 = 9600 (for all printers and OP-910X, OP-910XL) 4 = 14400</p>
Manual Zero Range	C20	<p>0 = turn off manually zero setting 1 = $\pm 1\%$ max capacity</p> <p>2 = $\pm 2\%$ max capacity</p> <p>4 = $\pm 4\%$ max capacity</p> <p>10 = $\pm 10\%$ max capacity 20 = $\pm 20\%$ max capacity 100 = $\pm 100\%$ max capacity</p>
Initial Zero Range	C21	<p>0 = no initial zero setting</p> <p>1 = $\pm 1\%$ max capacity</p> <p>2 = $\pm 2\%$ max capacity</p> <p>5 = $\pm 5\%$ max capacity</p> <p>10 = $\pm 10\%$ max capacity 20 = $\pm 20\%$ max capacity 100 = $\pm 100\%$ max capacity</p>

Zero Tracking	C22	<p>0= turn off zero tracking</p> <p>d = division</p> <p>0.5 = ±0.5d</p> <p>1.0 = ±1.0d</p> <p>2.0 = ±2.0d</p> <p>3.0 = ±3.0d</p> <p>4.0 = ±4.0d</p> <p>5.0 = ±5.0d</p> <p>Note: the zero tracking range can not be bigger than manual zero range</p>
Zero Tracking Time	C23	<p>0 = turn off zero tracking time 1 = 1 second</p> <p>2 = 2 seconds</p> <p>3 = 3 seconds</p>
Overload Range	C24	<p>00 = turn off overload range</p> <p>d = division</p> <p>01-99d = overload range setting</p>
Negative Display	C25	<p>0 = -9d</p> <p>10 = -10% max. capacity</p> <p>20 = -20% max. capacity</p> <p>50 = -50% max. capacity</p> <p>100 = -100% max. capacity</p>
Standstill Time	C26	<p>0 = quick</p> <p>1 = medium</p> <p>2 = slow</p>
Standstill Range	C27	<p>d = division</p> <p>1= 1d</p> <p>2 = 2d</p> <p>5 = 5d</p> <p>10 = 10d</p>
Digital Filter (for filtering moving weight such as animals)	C28	<p>0 = turn off dynamic filter</p> <p>1 = 1 digital filter strength</p> <p>2 = 2 digital filter strength</p> <p>3 = 3 digital filter strength</p> <p>4 = 4 digital filter strength</p> <p>5 = 5 digital filter strength</p> <p>6 = 6 digital filter strength</p> <p>Note: The higher the number, the higher the filter strength</p>

Noise Filter	C29	0 = turn off noise filter 1 = 1 digital filter strength 2 = 2 digital filter strength 3 = 3 digital filter strength
Print Time and Date	C30	0 = yy.mm.dd 1 = mm.dd.yy 2 = dd.mm.yy 3 = yy.mm.dd
Analog Output Setting	C31	0=0-5Vouput 1 = 4 - 20mA output
Calibrate Current	C32	4 - 20mA current
Relay Output Setting	C33	0 = turn off relay output 1 = turn on relay output function 1 2 = turn on relay output function 2 3 = Reserved menu
Gravity of Calibration Location	C36	9.7000 - 9.9999
Gravity of Destination	C37	9.7000 - 9.9999
Version No.	C38	
Print Mode	C41	0 = auto mode 1 = gross mode 2 = tare mode
Print Carriage Return	C42	0 - 9 (How much space between print outs)
Space Print	C43	0-9 Where the data prints on the paper: 0=left ; 9=right)
Date Print	C44	0 = do not print the date 1 = print the date
Time Print	C45	0 = do not print the time 1 = print the time
Baud Rade for 2nd RS232	C48	0 = 1200 (for remote display) 1 = 2400 2 = 4800 3 = 9600

Table 2. Unit Conversion Parameter Settings

Parameter Settings	Units Available
C01=3&C12=0	gram only
C01=4&C12=0	oz only
C01=1&C12=0	kg only
C01=1&C12=1	kg/lb
C01=1&C12=2	kg/lb/oz
C01=1&C12=3	kg/lb/lb:oz/oz
C01=1&C12=4	kg only
C01=2&C12=0	lb only
C01=2&C12=1	lb/kg
C01=2&C12=2	kg/lb/oz
C01=2&C12=3	kg/lb/lb:oz/oz
C01=3&C12=4	lb only

Table 3. Default Parameter Settings

Function	Parameter	Default Setting
Weighing Unit	C01	1
Decimal Setting	C02	0
Graduation Setting	C03	1
Maximum Capacity	C04	1000
Zero Calibration	C05	0
Calibration	C06	0
Restore Default	C07	0
Warning Tone	C08	1
Automatic Power Off	C09	0
Power Saving Mode	C10	0
Hold Function	C11	0
Unit Conversion	C12	1
Upper Limit Alarm	C13	000000
Lower Limit Alarm	C14	000000
Inner Code Display	C15	
Set Date	C16	
Set Time	C17	
Communication Setting	C18	0
Baud Rate	C19	3 (9600)
Manual Zero Range	C20	10
Initial Zero Range	C21	10
Zero Tracking	C22	0.5
Zero Tracking Time	C23	1
Overload Range	C24	9
Negative Display	C25	10
Standstill Time	C26	1
Standstill Range	C27	2

Digital Filter	C28	0
Noise Filter	C29	2
Print Time and Date	C30	0
Analog Output Setting	C31	1
Calibrate Current	C32	4
Relay Output Setting	C33	1
Multi-connection add.	C34	0
Wireless Communication	C35	6
Wireless Communication	C36	9.7936
Gravity of Destination	C37	9.7936

CONNECTORS

Connecting load cells to the indicator

- The indicator can connect with 6 load cells of 350Ω at most
- 4 wire or 6 wire load cell connections are both okay
- Please contact us directly if you have other special needs for your application

There are two connection methods between the load cell and indicator **Quick Disconnect as shown below:**

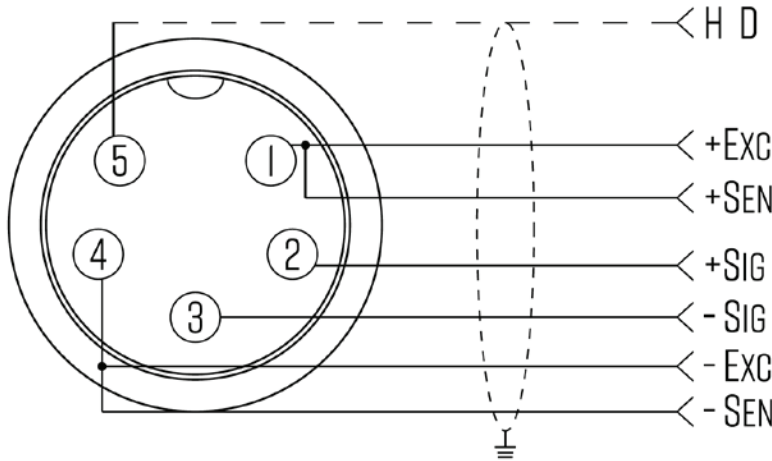

Hardwire (Using Inner Terminal Block Connection:

Note: Make sure you follow all the anti-static rules to avoid damage to your indicator

- Excitation voltage: 5V DC
- Largest output current: 120 mA
- Excitation circuit: 5 VDC, 4 wire connection, 6 load cell of 350ohm maximum
- Open the back cover of the weighing indicator, and insert signal cable to the terminal block; Make sure the screw on terminal block is fixed tightly.

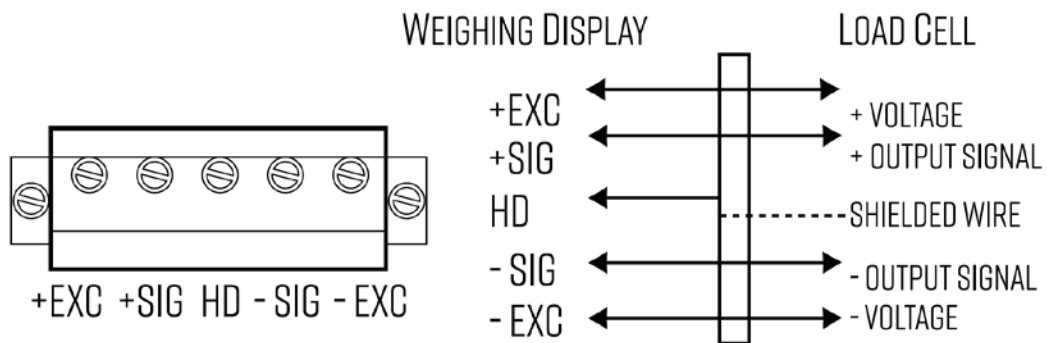

Table 4. Wiring Color Code

Signal Name	Color Code	Description
+Exe/ +EX	RED	Positive excitation voltage to load cell
+IN / +SIG	GREEN	Positive output signal from load cell
HD / SHLD	YELLOW/THICK BLACK	Shield Wire
-IN / -SIG	WHITE	Negative output signal from load cell
-EXC / -EX	BLACK	Negative excitation voltage to load cell

DB9 Connection (9 pin Serial Connector)

The DB9 9 pin serial connector is used for different purposes depending on the indicator model

- The Figure below shows the pin assignment on the DB9 9 pin connector

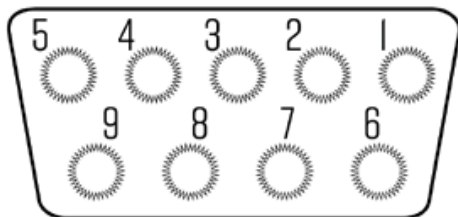

There are 3 Output formats to choose from

1. RS232SerialOutputFormat(Standard)
2. 4-20mAAAnalogOutput(Optional)
3. RelayOutput(Optional)

RS232 SERIAL OUTPUT FORMAT

When connecting the indicator to the RS-232 Serial device, follow the pin out of Table 5 below.

Table 5. DB9 Pin Description

DB9 Pin	Definition	Definition
2	TXT	Transmit Data
3	RXD	Receive Data
5	GND	Ground Interface

The serial output format depends on the settings for parameter C18. The serial output consists of a string of ASCII characters. Here is a list of the serial parameters

- 8 data bits
- 1 stop bits
- No parity
- No handshaking

Note: With the RS232 Output option we have data logging software available as seen in [Insert figure no.].

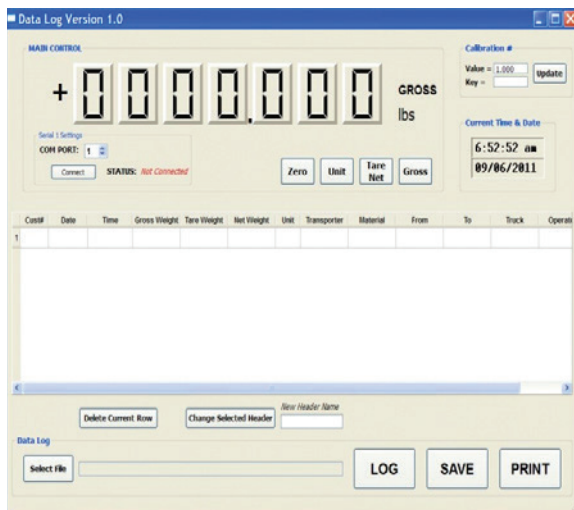

Below are the formats of the serial output

- C18=0 - Turn off serial interface data output
- C18=1 - Continuous sending mode, connect 2nd big display
- C18=2 - Print mode, connect printer
- C18=3 - Command request mode, connect computer.
- C18=4 - PC continuous sending mode, connect computer
- C18=5 - PC/big display, continuous sending mode
- C18=6 - Print to adhesive label printer
- C18=7 - Print to Zebra adhesive label printer
-

Output Continuous Format																	
S	S	S	S	X	X	X	X	X	X	X	X	X	X	X	X	C	C
T	W	W	W												R	K	
X	A	B	C												S	S	
1	2			3						4						5	6

State A			
Bits 0, 1,2			
0	1	2	Decimal point position
1	0	0	XXXXXX0
0	1	0	XXXXXXX
1	1	0	XXXXX.X
0	0	1	XXXX.XX
1	0	1	XXX.XXX
Bits3,4			
0	1		X1
1	0		X2

Satate B	
Bits5	function
Bits0	gross=0, net=1
Bits1	Symbol: positive=0, negative=1
Bits2	Overload (or under zero)=1
Bits3	dynamic=1
Bits4	unit: lb=0, kg=1
Bits5	Constant 1

State C			
Bit2	Bit1	Bit0	Units
0	0	0	Kg or lb
0	0	1	g
0	1	0	t
Bit 3			printing=1
Bit 4			Extend display=1
Bit 5			Constant 1
Bit 6			Constant 0

Print Mode (C18 = 2)

For printing on a non-adhesive ticket printer. Parameters 16, 17, 30, & 42-45 all effect your ticket print out.

Normal weighing ticket printout example:

Date:	05/01/2017
Time:	11:30:52
Net:	25.6lb
Tare:	10.3lb
Gross:	35.9lb

Accumulation weighing ticket printout example:

Date:	05/01/2017
Time:	11:30:52
n001	15.4lb
n002	17.2lb
n003	35.6lb
Total	68.2lb

Command Request Mode (C18=3)

In this mode, the indicator can receive ASCII commands as listed below

Command	Name	Function
1	Tare	Save and clear tare
2	Zero	Zero gross weight
3	Print	Print the weight
4	G.W/N.W	Read gross weight or net weight
5	Kg/lb	Kg/lb conversion
6	G.W	Check gross weight at net weight mode

The **R** command will trigger the indicator to output the following data format:

<STX>	<POL>	XXXX.XX	<SP>	<LB/KG>	<SP>	<GR/NT>	<CR>	<LF>
Start Transmission		Weight Data	Space		Space		Carriage Return	Line Feed
	Polarity: <SP>=Positive "-" = Negative			Units: lb = punt kg = kilogram pcs = pieces*		Gross/Net: GR = Gross NT= Net		

Computer Continuous Sending Mode (C18=4)

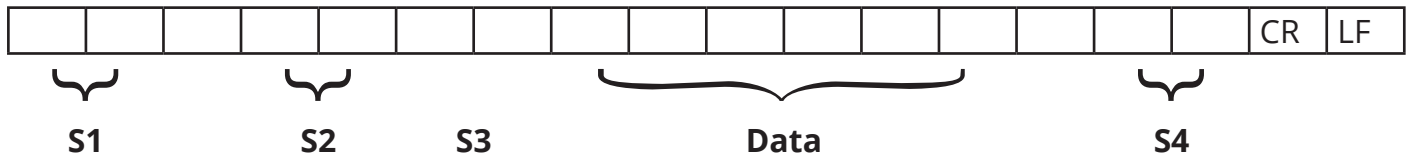

Symbol Interpretation

S1: weight status, ST=standstill, US=not standstill, OL=overload

S2: weight mode, GS=gross mode, NT=net mode

S3: weight of positive and negative, "+" or "-"

Data: weight value, including decimal point

S4: "kg" or "lb" CR: carriage return

LF: line feed

PC or Remote Display Continuous Sending Mode (C18=5)

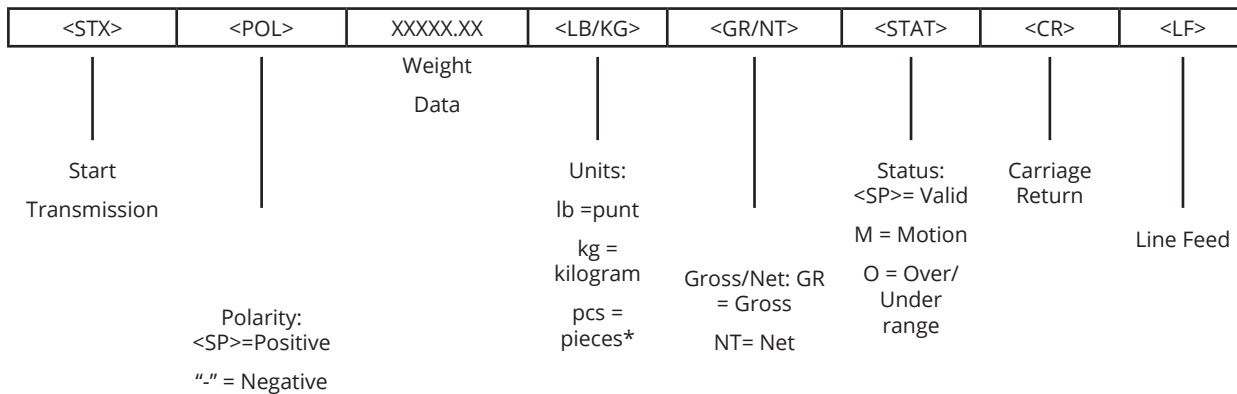

Print to Adhesive Label Printers (C18=5) & (C18=6)

The following are the printing formats:

Date:	05/01/2017
Time:	11:30:52
Net:	25.6lb
Tare:	10.3lb
Gross:	35.9lb

Prime Label Printer

Date:	xx.xx.xx (yy.mm.dd)
Time:	xx.xx.xx (hh.mm.ss)
Net:	6.00kg (net weight)
Tare:	2.88kg (tare)
Gross:	8.88kg (gross weight)

Zebra Label Printer

US-6011SS-4-20 mA Analog Output

The US-6011SS-4-20-mA analog output is a voltage sourcing sensor that outputs current proportional to the weight range of the calibrated scale (i.e. 4 mA = 0 LBS and 20 mA = 10,000 LBS). It is a sensor with a sourcing output (i.e. the sensor will source 9VDC with an output current range of 4-20 mA). An external supply voltage should not be connected to the unit's 4-20 mA circuit, unlike many other "loop powered" type 4-20 mA sensors; however, the ground connection (pin 6) of the DB-9 connector must be connected to the same ground as the data acquisition device responsible for interoperating the 4-20 mA signal.

This ground connection is imperative, as both the data acquisition device's power supply and the scale's internal 9VDC power supply will need to be on the same ground plane for the output current to be synced and measured correctly. Please refer to the figure below as a visual clarification on how to connect your scales 4-20 mA output to a data acquisition device.

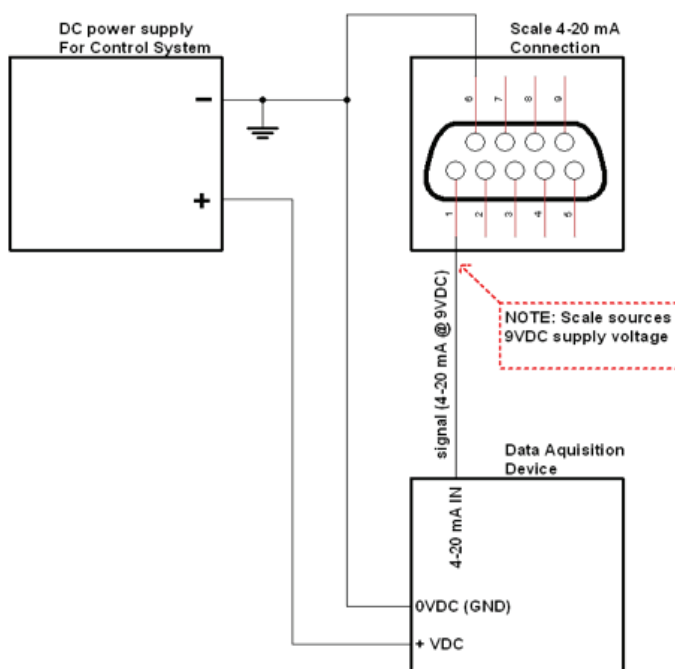

Highlights of using the 4-20mA option

- Resolution: 1/10000
- Outside Load: 100-350ohms
- Inside connection: load input port pin "1" of J2, ground port pin "GND" of J2
- Outside connection: load input port pin 1 of RS232, ground port pin 6 of DB-9 connector
- To test the connection, connect a 250 ohm load; Locate a volt meter, and probe across the 250 ohm load. As the weight input to the indicator varies, the voltage of the volt meter will change accordingly
- Pressing the TARE key will reset to output current to 4mA
- 0-20mA output can be set by setting parameter C31 to 0
- Please note that this option will disable the RS232 weigh data output that comes in the standard indicator

Calibration:

- Press **PRINT** and **HOLD** key to go into configuration mode
- Go to **C32** and press **PRINT** key
- The display should show **[out-4]** and output should be at **4mA**
- Press the **up/down** arrow keys and the **[out-#]** will increase/decrease

Note: X corresponds to the output current.

RELAY OUTPUT

The indicator can output 4 signals, which when connected to outside equipment, can perform an automatic control function and an upper/lower limit alarm function. You can change parameter setting C33 following Table 6 below:

Table 6: Relay Output Parameter Setting

	Output Port	Port Definition	Function
C33=0	Out1	Turn off output function	No Output Signal
	Out2	Turn off output function	No Output Signal
	Out3	Turn off output function	No Output Signal
	Out4	Turn off output function	No Output Signal
C33=1	Out1	Turn on overload control function	Output overload control signal
	Out2	Turn on compliance control function	Output compliance control signal
	Out3	Turn on under-load control function	Output under-load control signal
	Out4	Turn on stable control function	Output stable control signal
C33=2,3	Preserved, no function		

The RS232 port for the relay output option is shown in the Table 7 below, which also includes a definition of its pin.

Table 7: Relay Output Pin Definition

DB-9 Pin		Definition	Port
1	Red	1 st output signal pin	Out1
6	Red	1 st output signal pin	Out1
2	Green	2nd output signal pin	Out2
7	Green	2nd output signal pin	Out2
3	White	3rd output signal pin	Out3
8	White	3rd output signal pin	Out3
4	Black	4th output signal pin	Out4
9	Black	4th output signal pin	Out4

TROUBLESHOOTING

Error Codes	Reason	Solution
UUUUUUU	<ol style="list-style-type: none"> 1. Overload 2. Wrong connection with load cell 3. Load cell has quality problem 	<ol style="list-style-type: none"> 1. Reduce the weight 2. Check load cell connection 3. Inspect load cell; Check the input/output 4. See Q&A section
nnnnnnnn	<p>Calibration is no good</p> <p>Wrong connection with load cell Load cell has quality problem</p>	<ol style="list-style-type: none"> 1. Make sure scale is level 2. Check load cell connection 3. Check load cell input and output resistance 4. See Q&A section
Err1	Weight is not used during calibration, or the weight is above the maximum capacity	Use correct weight within the defined range
Err2	Weight is below the minimum requirement during calibration.	The calibration weight minimum is 10% of the max. capacity set in C04. Recommended to use 60%-80% of max. capacity if possible
Err3	The input signal is negative during calibration	<ol style="list-style-type: none"> 1. Check all wire connections 2. Check load cell 3. Recalibrate 4. PCB replacement needed if steps 1-3 fail
Err4	Unstable signal during calibration.	After the platform is stable, start calibration
Err5	EEPROM Error	Change PCB
Err6	Exceed Zero Range	See Q&A section

FAQs

Q:	The scale does not turn on
A:	Ensure that your cord is properly plugged into the wall socket when there is power supply. Confirm that there is power supply. One easy way to test this is by connecting another appliance to the same outlet and see if it is working.
Q:	The reading goes negative when a load is applied
A:	Try interchanging the Sig+ and Sig- wiring connected to the load cell and/or junction box (if one is used)
Q:	How do I resolve Err6 error?
A:	<p>Please follow the procedure below:</p> <ol style="list-style-type: none"> 1. Turn on the indicator and make sure nothing is on the scale, and that the scale is stable and not wobbling 2. Press and hold the "PRINTandHOLD" button together for a few seconds 3. The screen will display "C01" 4. Change C01 to C20 using the arrow buttons . You have to change the 1st digit from 0 to 2 first before you can change the 2nd digit 1 to a 0. 5. Press "PRINT" key to enter C20 parameter 6. Change the value of C20 on the right to 100 if possible using the up arrow key. 7. If 100 is not available change to 20 8. Press "PRINT" key to enter your selection 9. The screen will display "C21" 10.Press "PRINT" key to enter C21 parameter 11.Change the value on the right of C21 to 100 if available, 20 if not 12.Press "PRINT" key to enter your selection 13.The screen will display "C22" 14.Press "TOTAL" key to save and exit 15.Restart the indicator, and see if this resolves the ERR 6 issue. If not, then following the Q&A answers below for resolving "nnnnnn"and "uuuuuu" errors
Q:	How do I resolve "nnnnnn" and "uuuuuu" error?
A:	<ol style="list-style-type: none"> 1. Check to see if the cable that runs from the indicator to the junction box is damaged. If it is, replace the cable. 2. Open up the junction box (if available) and check to see if there is any water damage. If so, replace the junction box 3. Make sure all the wires on all 5 terminal blocks (5 wires on each terminal block)are not loose. Re-tighten the screws even if the wires seem to be connected 4. Recalibrate 5. If steps 1-4 do not work, there is a possibility one or more load cells are defective (consult with sales@usameasurements.com for further instructions)

You can send an email to sales@usameasurements.com for any questions about your sales or support.

Alternatively, call [800-711-2237](tel:800-711-2237) for sales and support. Visit our website at:
usameasurements.com